

Haier

Heat Pump Water Heater Operation and Installation Manual

Model

HP200M1-U1

HP250M1-U1



**SAA-230239-EA
AS/NZS 2712 SMK41331
AS 3498 WMK26822**



Please read this manual carefully prior to the installation and use of this appliance.
The appearance of the water heater given in this manual is for reference only.
This product must be installed outdoors.

Contents

1. Safety warnings.....	4
2. Functioning principles of heat pump water heaters	8
3. Technical specification	9
4. Description of parts and components.....	10
5. Transport and storage instructions	12
6. Installation instructions	12
7. Commissioning checklist.....	19
8. Operating functions	20
9. Checking and maintenance	25
10. Faults and protection	27

Dear users of Haier,

Thank you for choosing Haier products.

Please read this manual carefully and follow the operation and safety instruction to ensure best installation and utilisation of the product.



Product safety statement:

1. This appliance is not intended for use by persons with reduced physical, sensory or mental capabilities, persons with a lack of experience and knowledge, or children under the age of 8 years. Persons in this group must be supervised while using the appliance by a person responsible for their safety.
 2. Children should be supervised to ensure that they do not play with the appliance.
 3. Installation must be carried out by qualified professionals. Do not open the cover or panel unless qualified to undertake this work. Contact Haier Customer Service if service or repair work is required.
 4. This appliance must be permanently connected to mains water supply and continuous electrical supply.
-

Warning: flammable hazard!



1. Please read the instructions carefully before installation and use of this appliance.
2. Do not puncture or ignite this product.
3. The environment-friendly refrigerant R290 used in this product is odorless.
4. This product must be installed outdoors.
5. This product cannot be discarded or scrapped without correct retrieval of the refrigerant.
 - a. If necessary, please contact Haier Customer Service to obtain the correct disposal method.
6. The product must not be stored in an area containing an open flame such as an open fire, gas appliance or electric heater.
7. Before the refrigeration system is repaired, the refrigerant must be removed by a qualified professional.
8. Do not use any method to accelerate the defrosting process or clean frosted components of the appliance.

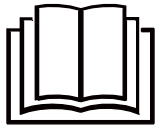

Warning: Risk of damage to the environment









This heat pump contains R290 refrigerant. This refrigerant must not escape into the atmosphere.

Refrigerant must be removed and disposed of by a qualified professional.

Safety warnings – To be followed at all times

Interpretation of marks and symbols

Failure to follow these instructions may lead to serious malfunctions of the device and danger to the user.

	Instructions marked with this symbol must be followed. Failure to do so may lead to product damage and harm to the user.
	Information marked with this symbol are forbidden. Failure to follow this instruction may lead to product damage and harm to the user.
 <p>The water heater shall be installed in strict accordance with local wiring regulations. The power supply must have a grounding line. Ensure an effective ground connection.</p>	 <p>Ground and neutral lines of the power supply must not be connected. The ground line shall not be connected to gas or water pipes, lightning arresters or telephone lines.</p>
 <p>The water heater must be installed in a location where suitable water drainage is possible.</p>	 <p>The water heater must be installed outside.</p>
 <p>This appliance must be fitted with the pressure temperature relief valve (PTR valve) supplied with the appliance. The PTR valve must be fitted directly to the appliance.</p>	 <p>While bathing, children must be under guidance of an adult. Children must not play with the appliance.</p>

Safety warnings – To be followed at all times

<p>⚠</p> <p>The outlet water temperature of a water heater is typically higher than the temperature indicated on the display. Ensure that contact to hot water directly leaving the appliance cannot occur.</p>	<p>⚠</p> <p>This appliance must be installed with an isolation switch to the power supply. This switch must ensure full disconnection and be in accordance with the wiring rules.</p>
<p>⚠</p> <p>Install the water heater in strict accordance with these installation instructions.</p>	<p>⚠</p> <p>If the power cord is damaged, it must be replaced by a qualified professional.</p>
<p>⚠</p> <p>Do not put hands or other items into the air grid. This may cause injury or damage to the appliance.</p>	<p>⚠</p> <p>Risk of damage to the environment. This heat pump contains the refrigerant R290.</p>
<p>⚠</p> <p>The PTR valve drain must be installed in a continuously downward direction, be open to the atmosphere, be free from blockages, and the potential to frost.</p>	<p>⚠</p> <p>The PTR valve must be operated every six months to remove lime deposits, and to ensure that it is free from blockages.</p>

Safety warnings – To be followed at all times

1. Installation, service, or maintenance of this appliance must be carried out by a qualified professional. Failure to adhere to this may result in damage to the appliance or other property, or cause injury.
2. Fit the appliance in accordance with this installation manual.
3. Be sure to use only certified parts and accessories in the installation of this appliance.
4. Install the product on a base that can hold the filled weight of the appliance.
5. Electrical work must be performed in accordance with all local standards and regulations, including AS/NZS3000, and the instructions in this manual.
6. This appliance must be connected to a dedicated electrical circuit.
7. During installation, ensure that the ground wire is disconnected last.
8. If a refrigerant leak occurs, ventilate the area immediately. The refrigerant is flammable, so damage or injury is possible if it reaches an open flame.
9. Be aware that the refrigerant contained in this appliance does not have an odour.
10. Do not accelerate the defrosting process or clean the evaporator when frosted. Only a qualified person should clean the evaporator.
11. Do not pierce or burn this appliance.
12. This appliance must be installed outside and be well ventilated. A gas leak in a poorly ventilated area could create an explosion risk.
13. Prevent insects and small animals entering the appliance. This may cause electrical shorts, malfunctions or fire.
14. Only qualified personnel can handle, fill, purge and dispose of the refrigerant in this appliance.
15. If installed in a coastal or high sulfate gas region, corrosion will occur shortening the appliance life.

Safety warnings – To be followed at all times

Loading and unloading requirements

1. This appliance shall be carefully handled during transport loading and unloading.
2. Ensure that the appliance is not dropped, bumped, or rolled during transportation as this could cause damage to the appliance, potentially creating a refrigerant leak.

Transport requirements

1. Local transport regulations should be consulted to determine the maximum allowable appliance quantity or refrigerant (R290) volume that can be transported at any one time.

Storage requirements

1. As this appliance contains a flammable refrigerant R290, its storage must be in accordance with local regulations.
2. The storage should ensure that there is no potential for damage to the appliance. Any damage could result in a refrigerant leak.

Scrapping and recovery requirements

1. Scrapping must only be carried out by a qualified professional. This professional must safely recover the appliance's refrigerant before the appliance is scrapped. Contact Haier Customer Service to correctly dispose of this appliance.

Technical specifications

Functioning principles of heat pump water heaters

Air source heat pump water heaters mainly consist of a compressor, an expansion valve, a filter, an evaporator, a condenser, and a fan. Powered by electricity, the compressor absorbs low-temperature and low-pressure refrigerant gas from the evaporator. It compresses the gas into high-temperature and high-pressure gas, which is passed through the condenser to transfer heat to the water. The condensed refrigerant is then throttled and depressurized by the expansion valve. It then absorbs heat from the surrounding air via the evaporator.

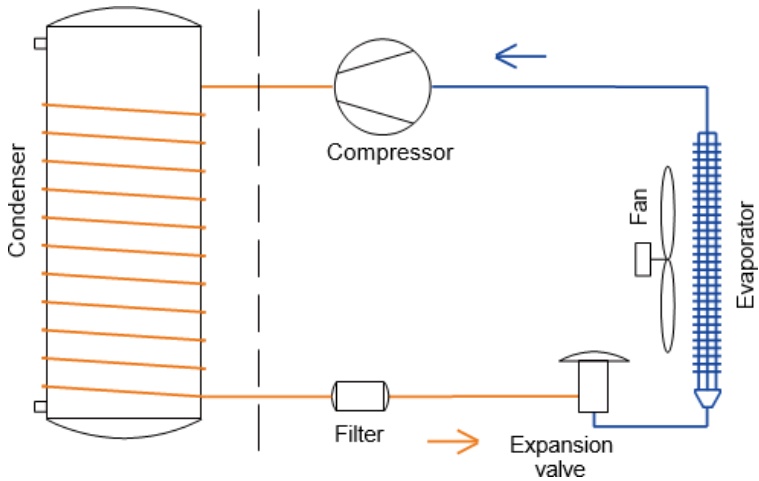

Technical specifications

Model	HP200M1-U1	HP250M1-U1
Tank		
Total water capacity	195L	246L
Rated voltage/ frequency	220-240V/50Hz	220-240V/50Hz
Tank max pressure	700kPa	700kPa
Corrosion protection	Magnesium rod	Magnesium rod
Waterproof grade	IPX4	IPX4
Performance (20°C/15°C Ambient air temperature, 15°C -55°C water temperature)		
COP* @ 20°C/15°C	4.49	4.48
Power input of electric element	1500W	1500W
Rated power input of heat pump	430W	430W
Maximum power input of heat pump	750W	750W
Maximum power input	2250W	2250W
Average heating capacity by heat pump	2000W	2000W
Heating water capacity	42L / h	42L / h
Heating up time (15°C-55°C)	4.6h	5.8h
Default temperature setting	60°C	60°C
Temperature setting range- with heater	35°C – 75°C	35°C – 75°C
Max temperature of the heat pump only	65°C	65°C
Max working pressure of refrigerant	1.0/3.3MPa	1.0/3.3MPa
Refrigerant type / weight	R290/0.34kg	R290/0.34kg
Sound pressure level * @ 1m	43dB(A)	43dB(A)
Ambient temperature for heat pump and element	-7~45°C	-7~45°C
Ambient temperature of heat pump	-7~45°C	-7~45°C
Dimension and connections		
Water inlet and outlet connection	Rp ¾"	Rp ¾"
TPR valve connection	Rp ¾"	Rp ¾"
Drain & Water inlet connection	Rp ¾"	Rp ¾"
Product Dimensions	600*630*1658mm	600*630*1951mm
Packing dimension with pallet	736*695*1940mm	736*695*2250mm
Net/Gross weight	91/116kg	106/128kg
Filled weight of the appliance	286kg	352kg
<p>* The COP was measured under test conditions with an ambient air temperature of 20°C/15°C (Dry Bulb/Wet Bulb) and heating of the water from 15°C to 55°C during water heater operation.</p> <p>* The noise level was measured at 1 m from the water heater during a Noise Test conducted to Standard GB/T 23137 in a hemi-anechoic chamber within a laboratory.</p>		

Description of parts and components

Heat pump layout

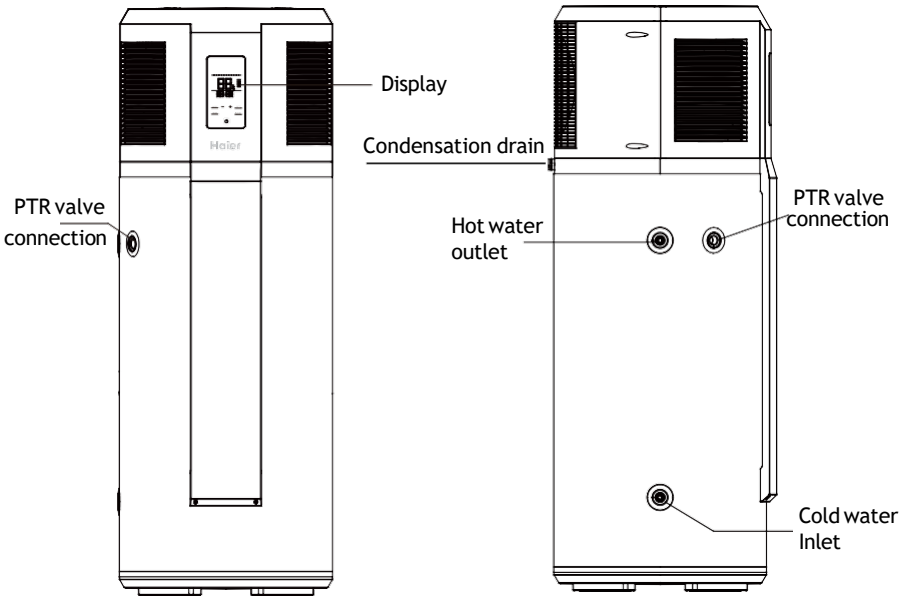

Carton contents

Part name	Heat pump water heater	TPR valve	Instruction manual
Quantity	1	1	1

Description of parts and components

Exploded view of the heat pump

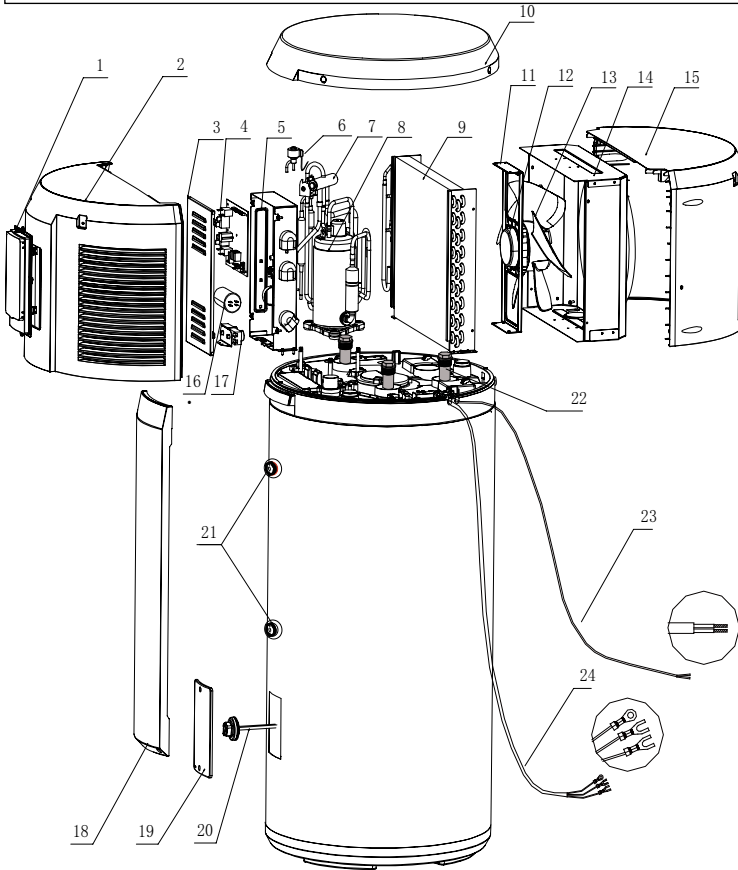

S/N	Description	S/N	Description
1	Display panel & Cover	13	Fan blade
2	Front shell	14	Diversion air duct
3	Electrical box cover	15	Rear shell
4	Control panel	16	Compressor capacitance
5	Electrical box	17	Thermal cut-out
6	Electronic expansion valve	18	Decorative cover
7	Four-way valve	19	Waterproof cover
8	Compressor	20	Heating element
9	Evaporator	21	Sensor pocket
10	Top cover	22	Magnesium anode
11	Support	23	Communication cable
12	DC motor	24	Power cable

Installation instructions

Transporting the appliance

1. During transport or storage, the heat pump water heater should remain in undamaged packaging to prevent damage to the appliance.
2. During long periods of transport or storage, the heat pump water heater must be in an upright position.
3. For short distance transportation (under one hour), this product may be laid down within 1 hour as per indication on packaging. If laid down, the appliance must be at an upright position for 4 hours prior to its initial startup.

Selection of installation site

1. Ensure the install location is stable and level, and that air can flow in and out freely, and will be minimally affected by wind.
2. The base or surface can support the filled weight of the appliance and the condensate water can be drained freely.
3. If installed on a base, ensure that this base is level to allow correct drainage via the condensate drain at the rear of the appliance.
4. The location or position of the appliance will not create nuisance noise for the homeowners or neighbors, especially through proximity to bedrooms.
5. Ensure that the location allows condensate and PTR valves to be drained into an area that will not cause damage to the surrounding area.
6. There is sufficient space left for installation and maintenance of the appliance.
7. There is no strong electromagnetic interference around the appliance that may affect its control functions.
8. There are no corrosive vapors such as aerosol sprays, stain removers or household chemicals near the install location. These vapors may corrode the appliance and its fittings.
9. Considerations have been made to prevent water pipes from freezing in colder regions.

Installation instructions

Installation dimensions

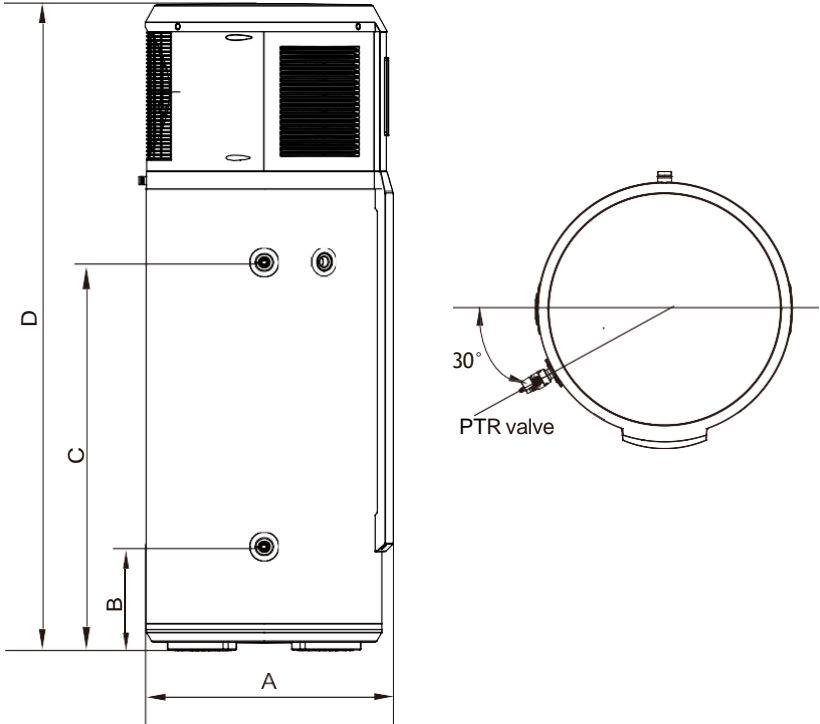

unit: mm

Model	A	B	C	D
HP200M1-U1	630	267	979	1658
HP250M1-U1	630	267	1272	1951

Installation instructions

Installation clearances

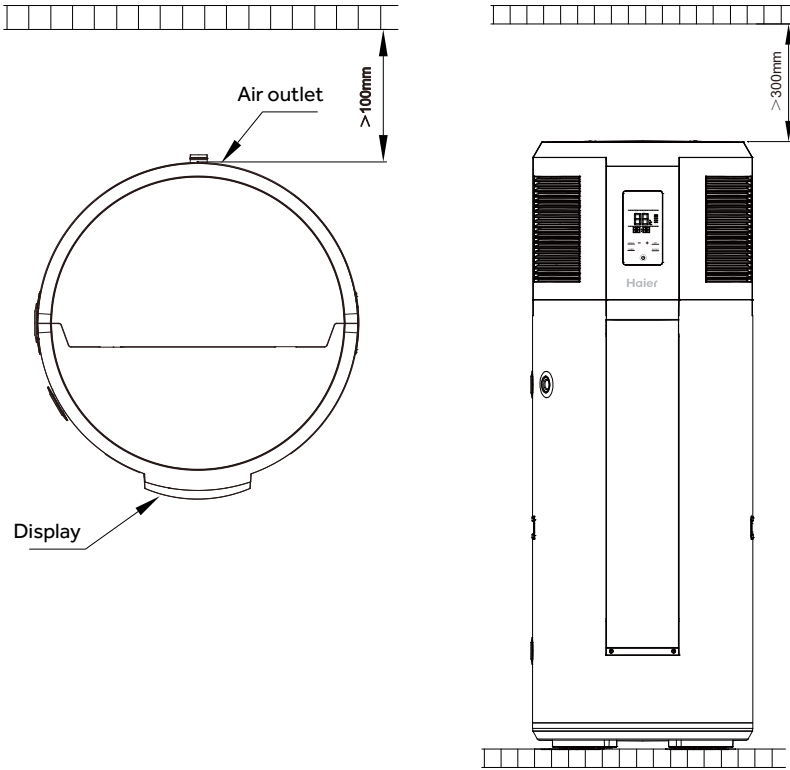

Note: This appliance must be installed in a location where it can be quickly and easily drained and moved to a location with 1000mm clearance above the appliance. This is so the anode to be removed for checking and replacing during the 5 yearly service.

Installation instructions

Plumbing installation

WARNING — FOR CONTINUED SAFETY OF THIS APPLIANCE IT MUST BE INSTALLED, OPERATED AND MAINTAINED IN ACCORDANCE WITH THE MANUFACTURER'S INSTRUCTIONS.

WARNING — THIS APPLIANCE MAY DELIVER WATER AT HIGH TEMPERATURES. REFER TO THE PLUMBING CODE OF AUSTRALIA (PCA), AND ALL LOCAL REGULATIONS ON ADDITIONAL DELIVERY TEMPERATURE CONTROL MUST BE FOLLOWED.

1. The water heater must be installed:
 - a. by licensed trades people.
 - b. in accordance with all local codes and regulations and standards including AS/NZS3500.4, AS/NZS 3000, and the Plumbing Code of Australia (PCA).
2. The inlet water pressure of water supply must be between 100kPa – 500kPa.
3. Inlet water connections: An isolating and non-return valve must be installed on the inlet to the appliance. If the supply pressure could exceed 500kPa, a pressure limiting valve must be installed on the cold-water inlet. If a cold water expansion control valve (ECV) is required by local regulations, a valve of a maximum of 600kPa can be fitted. The correctly sized pressure limiting valve should also be fitted as per the ECV manufacturers specifications.

If no ECV is fitted, a pressure limiting valve of a maximum of 500kPa should be fitted.

4. The cold-water inlet to the appliance must have a line filter, non-return valve and isolating valve fitted. Combination valves of these functions are also suitable.
5. Outlet water connections: A thermostatic mixing or tempering valve must be used when hot water is supplied to fixtures used for sanitary use (i.e. bathrooms) according to AS/NZS 3500.4 requirements.
6. For ease of assembly and disassembly of the appliance, it is recommended that mechanical joints are used to connect to the water heater.

Installation instructions

Plumbing installation continued

7. The water inlet and outlet pipes must be fitted to as per the labels at the hot and cold-water connections.
8. To avoid damage to the appliance, the inlet water temperature should remain between 10-40°C.
9. Before filling the tank, make sure that the cold-water inlet and hot-water outlet of the appliance are open, along with the farthest hot water fixture are opened. The appliance will be correctly filled once water flows continuously from this fixture without air bubbles. Venting through the PTR could cause premature failure of the valve.
10. If there is a risk of freezing, hot and cold water pipes connected to the appliance must be insulated with 20mm insulation. Failure to adhere to this may result in a voided warranty if damage due to freezing occurs.
11. In accordance with safety rules, a PTR valve (700kPa, 99°C, Rp3/4") must be installed directly into the PTR valve connection on the appliance. Never block the outlet of the safety valve or its drain line for any reason.

Installation instructions

Electrical installation

CAUTION: In order to avoid inadvertent resetting of the thermal cut-out, this appliance must not be supplied through an external switching device, such as a timer, or connected to a circuit that is regularly switched on and off by the utility (off-peak electrical line).

Electrical Safety Requirements

1. The installation, service or repair of the electrical components of this appliance must be completed:
 - a. by licensed trades people.
 - b. in accordance with all local codes and regulations and standards AS/NZS 3000.
2. The surrounding conditions (ambient temperature, direct sunlight and rainwater) shall be considered during electrical wiring, with effective protective measures taken to suit the environment.
3. Materials that are certified to local standards must be used in the installation of this appliance.
4. The appliance must be reliably earthed.
5. This appliance must be connected to a dedicated circuit. This circuit must be fitted with a circuit breaker that is no greater than 20 A. It is recommended that a residual current device (RCD) is also fitted.
6. The circuit to the appliance should be a minimum of 2.5mm² 2-core and earth.

Installation instructions

Seismic strapping

FOR NEW ZEALAND INSTALLS ONLY

The Plumbing and Drainage standard (AS/NZS 3500.4) requires all storage water heaters in New Zealand to be installed with seismic restraints to avoid damage or personal injury if a seismic event should occur.

To meet this requirement this appliance should be fitted with three stainless steel straps, 25mm wide x 1mm thick.

These straps should be fitted as per the following instructions:

Top strap: Under the front cover, and no more than 100mm from the top the painted cylinder section of the appliance

Middle strap: Under the front cover, at the center of the painted cylinder section of the appliance

Bottom strap: Below the front cover, and no more than 100mm from the bottom the painted cylinder section of the appliance.

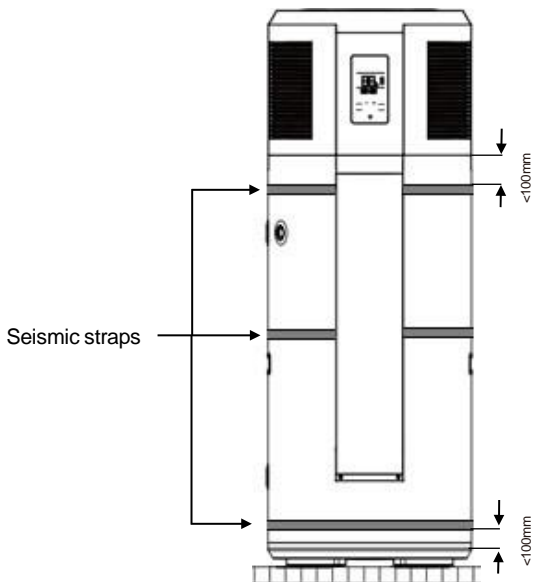

Installation instructions

Wiring diagram

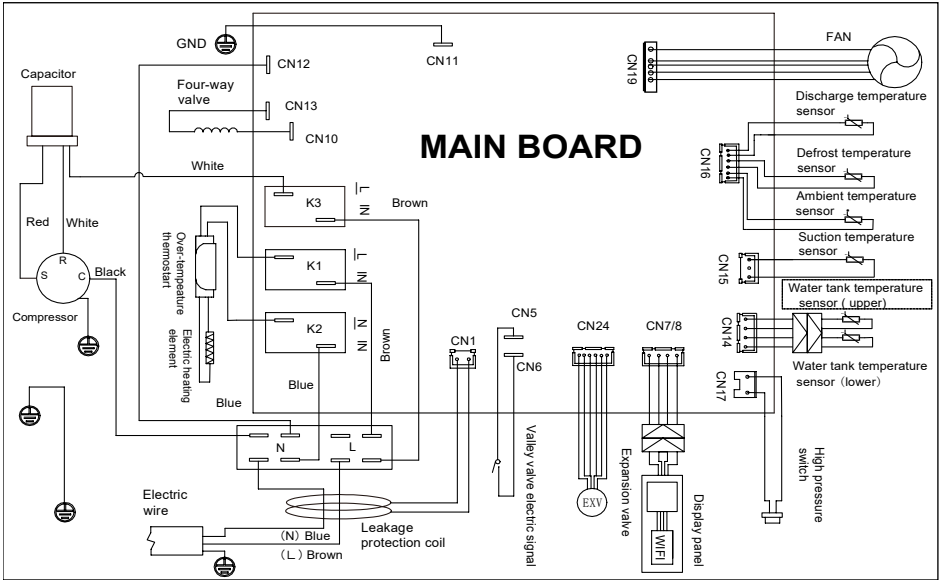

Commissioning checklist

Installers should check that the following tasks have been completed correctly during the commissioning of this appliance.

- The electrical connection is correctly hard wired.
- Water connections have been fitted correctly and are leak free after the appliance is filled.
- The control panel is operational.
- The supplied PTR valve has been correctly fitted to the appliance, and releases water when the lever is pulled.
- All hot water lines are correctly insulated.

Description of the icons

Operating functions





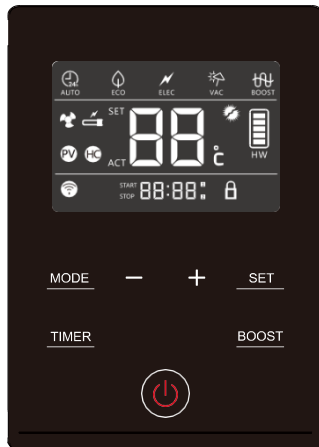



Display

Functions & Protections











- A. **Electrical leakage protection**
This appliance features an electricity leakage protection function.
- B. **Compressor protection**
When switched on, the appliance will take approximately 3 minutes to start the compressor for heat pump heating.
- C. **Automatic defrosting function**
The defrosting mode is automatically activated if the outdoor temperature is low and the compressor has run for some time.
- D. **Overload protection**
The working load of the compressor will be high in warm ambient air temperatures. To meet hot water requirements and to lengthen appliance life, this product automatically adjusts the fan speed to ensure reliable operation of the compressor.
- E. **Anti-freezing function**
The heat pump maintains a minimum temperature to avoid damage to the appliance caused by freezing.

Description of the icons

Symbol	Description
	Power ON/OFF switch
	Working mode selection
	Confirming the selection
	Timer adjustment
	Boost mode. Heat pump and backup element heat simultaneously for a faster recovery time.
	<u>Auto mode</u> <ul style="list-style-type: none"> - Optimised management of the heat pump and backup element for guaranteed comfort - The compressor maximum continuous working time (RR) can be adjusted in the installer settings.
	<u>ECO (off-peak) mode</u> <ul style="list-style-type: none"> - Prioritizes heat pump heating via two methods 1 - User entered timer settings 2 - Communication from power companies.
	<u>Electric heating mode</u> <ul style="list-style-type: none"> - In this mode, the backup element is used as the only heat source. - This function ensures hot water supply when the heat pump is not working properly.
	<u>Vacation mode</u> <ul style="list-style-type: none"> - Maintains a minimum temperature to prevent freezing, then heats to the set temperature for the owners return. Set by number of days by the owner.





Description of the icons

Symbol	Description
	Boost mode. Heat pump and backup element are activated at the same time (only in AUTO mode).
	Heat pump working icon.
	Auxiliary electrical heater working icon.
	When the PV function is turned on, the setting temperature will be automatically adjusted to 65°C, when the PV effective signal is received, the heat pump and electric heating will be turned on at the same time.
	Time of peak/off-peak hours. In Time of peak/off-peak hours mode, the symbol corresponding to the mode is displayed. When receiving the signal, "HC" lights up.
	<u>Anti- legionella</u> - Anti-legionella function will be activated every 7 days to heat the tank to 65°C automatically .
	Hot water volume display.
	WIFI signal icon.
	<u>Lock screen display icon</u> 1. Enter: In the power-on state, press and hold TIMER+BOOST (combination key) for 6s at the same time, the lock sign will be on, and the screen lock mode will be turned on. 2. After the screen lock mode is turned on, the device will not respond when the user touches any key. 3. Exit: press and hold TIMER+BOOST (combination key) for 6s at the same time, the lock sign is closed, and the screen lock mode is exited.

Note: Under certain conditions, ECO mode may result in shortages of hot water if the ambient air temperature is low.

Operating functions



Installer settings & WIFI connection

- To open the installer settings, press  switch off the system, then press  and **SET** at the same time for 10 seconds.
- When menu is open, press  or  to change the value of the settings.
- Press **SET** to confirm the settings.
- Press  to close the menu.

Parameters	Description	Factory setting	Adjustment range
LL NO, NC	<p>Off-peak signal type</p> <p>When you use off-peak time clock control, first determine the type of signals. Only allow professional installers to operate.</p> <p>- NO corresponds to Normally Open Signal. - NC corresponds to Normally Close Signal.</p>	NO	NO, NC
LP 01, 02 03	<p>Off-peak logic type</p> <p>- In two ways using heat pump. should set in the installer settings</p> <p>-01 manually set off-peak time. -02 switch signals by power companies. -03 PV signal.</p>	01	01, 02, 03
LA ON, OFF	<p>PV function can be executed in AUTO mode (03 is selected in LP)</p> <p>- ON corresponds to turned on PV function. - OFF corresponds to turned off PV function.</p>	ON	ON, OFF
Lb 65-75	<p>Temperature setting in PV function (03 is selected in LP)</p> <p>- The temperature setting is adjustable between 65°C and 75°C.</p>	65	65-75
LC 01, 02 03	<p>Heat source selection in PV function (03 is selected in LP)</p> <p>-01 Compressor and electric heating work at the same time. -02 The compressor shall be started first. When the system does not meet the operating conditions, the electric heating can be started. -03 Only electric heating is operated.</p>	01	01, 02, 03
AL ON, OFF	<p>Avoid Legionella</p> <p>- This parameter is used to activate the legionella protection mode. - Once every 7 or 30 days, all domestic hot water is heated to 65-75°C.</p>	ON	ON, OFF
AH 65-75	<p>Anti-legionella temperature setting</p> <p>- The Avoid Legionella temperature is adjustable between 65°C and 75°C.</p>	65	65-75
Ad 07, 30	<p>The frequency of Anti-legionella</p> <p>- The frequency of Anti-legionella is adjustable. 7 days and 30 days are optional.</p>	07	07, 30

Operating functions

Installer settings & WIFI connection

Parameters	Description	Factory setting	Adjustment range
	<u>Compressor maximum continuous working time</u> - If the maximum continuous working time of the compressor more than Set Time, start auxiliary power.	10h	5-15h
	<u>Set the day of the week</u> - Set the day of the week, d1 to d7 for Monday to Sunday, and remember the day of the week.	/	d1-d7
	<u>Reheat differential temperature setting</u> - Reheating will start in the 200L at 10°C below the set temperature. The 250L will start at 9°C below the set temperature. The adjustment range is 5-15°C.	9/10	5-15

WIFI connection

Your appliance can be connected to your home wireless network and operated remotely using the app.

Getting started:

1. Ensure your home Wi-Fi network is turned on.
2. Press and hold " - " to enter the distribution network status. At this time, the WIFI icon (📶) will flash. If the connection is successful the WIFI icon (📶) will always be on.
If the connection is not successful, the WIFI icon (📶) will always be flashing.
3. It may take up to 10 minutes to connect your appliance.

On your mobile device:

1. Download the app from www.fisherpaykel.com/connect
2. Register and create an account.
3. Add your appliance and set up the Wi-Fi connection.

Checking and maintenance



- Installation and maintenance of the appliance must be undertaken by a qualified professional.
- Before working on the appliance, shut down the machine and isolate the power supply at the switch.
- Do not touch with wet hands.
- Maintenance operations are important to guarantee optimal performance and extend the life of the appliance.

Checking the PTR valve

- Operate the PTR valve at least once every six months to ensure it is functioning correctly. If the valve fails to release water when the lever is activated, check for blockages. If none exist, call Haier Customer Care or a qualified professional to resolve the issue.

Checking the pipework

- Check the watertightness of the water connections and piping.

Cleaning the fan

- The fan should be checked for dust annually. If cleaning is required call Haier Customer Service or a qualified professional.
- Checking and cleaning the evaporator must be completed by a qualified professional.



- The evaporator fins are sharp and are a potential injury risk.
- Avoid damaging the evaporator fins as this can affect the performance of the appliance.

- It is recommended that the evaporator is cleaned every two years. Clean the evaporator with a soft brush and water if required. Do not use cleaners on the evaporator fins.

Checking the condensate drain

- Check the condensate drain for blockages as they have the potential to flood the appliance.

Checking the anode

- Checking and replacing the anode must be carried out by a qualified professional.
- To avoid irreversible corrosion of the cylinder, it is recommended to check the anode every five years, and replaced if required.

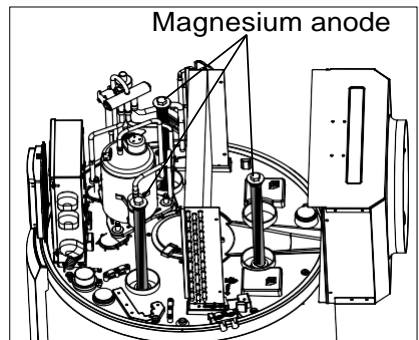

Faults and protection

Water Quality



A breach of this condition may void the warranty in the event of damage caused by water quality exceeding these characteristics.

Water supply from an unfiltered water source that may be highly conductive or have a high mineral content may void the system warranty.

The following characteristics should not be exceeded in order for the warranty to be conditions not to be breached.

Water Properties	Acceptable Levels
Total hardness	200 mg/litre or ppm
Total Dissolved Solids (TDS)	600 mg/litre or ppm
Chloride	250 mg/litre or ppm
Magnesium	10 mg/litre or ppm
Sodium	150 mg/litre or ppm
pH	Min 6.5 to Max 8.5
Electrical conductivity	850 μ S/cm

Faults and protection

Fault type	Action	Digital indication	Release
Communication fault	Communication failure between Wi-Fi module and control board	F0	Please call Haier Customer Service to resolve the issue.
Compressor protection	Operating temperature protection	F2	
	Air exhaust temperature protection	F3	
	Evaporation high temperature protection	F5	
Compressor over-current protection	Over-current protection	F6	Please call Haier Customer Service to resolve the issue.
Electricity leakage alarming	The system will automatically cut off power supply if any line fault occurs	E1	
Over temperature alarming	The actual water temperature \geq 85°C	E2	
Fault of the inner temperature sensor	If short circuit or circuit break occurs to the sensor	E3	
Fault of the ambient temperature sensor	If short circuit or circuit break occurs to the sensor	E4	
Fault of the evaporation temperature sensor	If short circuit or circuit break occurs to the sensor	E5	
Fault of the air exhaust temperature sensor	If short circuit or circuit break occurs to the sensor	E6	
Fault of the air intake temperature sensor	If short circuit or circuit break occurs to the sensor	ED	
Communication fault	Communication of main control panel and display panel is abnormal	E7	
Pressure switch protection	Action of the pressure switch at the exhaust outlet	E8	
Ambient temperature protection	Ambient or outdoor temperature <-7°C or>45°C	E9	
Fault of the Off-peak power switching signal	If not received the Off-peak signal when selecting switch signals by power companies	EF	
Fault of the fan	Fan blade is stuck or fan and control panel communication failure	L7	



The  symbol on the product or on its packaging indicates that this product is not to be treated as regular household waste. It must be taken to a recycling collection point for electronic equipment. By properly disposing of this product, you are contributing to the preservation of the environment and the wellbeing of your fellow citizens. Improper disposal is hazardous to health and environment. You can obtain further information on how to dispose of this product correctly by calling Haier Customer Service.

Haier

Haier Appliances

Australia 1300 729 948 | haier.com.au

New Zealand 0800 424 372 | haier.co.nz

Fisher & Paykel Australia Pty Ltd, Level 1, 1 Eden Park Drive, Macquarie Park, NSW 2113.

Phone Customer Care: 1300 729 948 Email: customer.care@haier.com.au

Fisher & Paykel Appliances Ltd, 78 Springs Road, East Tamaki, Auckland 2013.

Phone Customer Care: 0800 424 372. Email: customer.care@haier.co.nz

0040511380

20230228

V*****