



ASW05kH/06kH/08kH/10kH/12kH-T2
ASW05kH/06kH/08kH/10kH/12kH-T2-O
ASW08kH/10kH/12kH-T3
ASW08kH/10kH/12kH-T3-O

Three phase hybrid inverter

Quick Installation Guide



Android



iOS

1 General Information

This quick installation guide does not replace the description in the user manual.

The contents of this guide may be updated or revised due to product development. The information in this guide is subject to change without notice. The latest version of this document and the manual for installation, commissioning, configuration and decommissioning are to be found in PDF format at www.solplanet.net.

2 Safety

2.1 Intended use

The product is a transformerless hybrid inverter with 2 or 3 MPP trackers and a battery connection that feeds the direct current of the PV array into the connected battery or converts it to grid-compliant three-phase current and then feeds it into the utility grid. The product also can convert the direct current supplied by the battery into grid-compliant three-phase current. The product has a backup function that can continue to supply selected circuits with power from the battery or PV system in the event of a grid fault.

The product is intended for indoor and outdoor applications.

The product must only be connected with PV modules of protection class II (in accordance with IEC 61730, application class A). Do not connect any sources of energy other than PV modules to the product.

The product is not equipped with an integrated transformer and therefore has no galvanic isolation. The product must not be operated with PV modules which require functional grounding of either the positive or negative PV conductors. This can cause the product to be irreparably damaged. The product may be operated with PV modules with frames that require protective earthing.

All components must remain within their permitted operating ranges and their installation requirements at all times.

Use the product only in accordance with the information provided in the user manual and with the locally applicable standards and directives. Any other application may cause personal injury or damage to property.

The product must only be operated in connection with an intrinsically safe lithium-ion battery approved by AISWEI. The entire battery voltage range must be completely within the permissible input voltage range of the product.

The product must only be used in countries for which it is approved by AISWEI and the grid operator.

The type label must be permanently attached to the product and must be in a legible condition.

This document does not replace any regional, state, provincial, federal or national laws, regulations or standards that apply to the installation, electrical safety and use of the product.

2.2 Important safety instructions

The product has been designed and tested strictly according to the international safety requirements. As with all electrical or electronic devices, there are residual risks despite careful construction. To prevent personal injury and property damage and to ensure long-term operation of the product, read this section carefully and observe all safety information at all times.

DANGER

Danger to life due to high voltages of the PV array or the battery!

The DC cables connected to the battery or the PV array may be live. Touching the DC conductors or the live components can cause to lethal electric shocks. If you disconnect the DC connectors from the product under load, an electric arc may occur leading to electric shock and burns.

- Do not touch non-insulated cable ends.
- Do not touch the DC conductors.
- Do not touch any live components of the product.
- Do not open the product.
- Observe all safety information of the battery manufacturer.
- All work on the product must only be carried out by qualified personnel who have read and fully understood all safety information contained in this document and the user manual.
- Disconnect the product from all voltage and energy sources and ensure it cannot be reconnected before working on the product.
- Wear suitable personal protective equipment for all work on the product.

DANGER

Danger to life due to electric shock when touching live components in backup mode!

Even if the AC breaker and the PV switch of the inverter are disconnected, the parts of the system may still be live when the battery is switched on due to backup mode.

- Do not open the product.
- Disconnect the product from all voltage and energy sources and ensure it can not be reconnected before working on the product.

DANGER

Danger to life due to fire or explosion when batteries are fully discharged!

A fire may occur due to incorrect charging of fully discharged batteries. This can result in death or serious injury.

- Make sure that the battery is not fully discharged before commissioning the system.
- Contact the battery manufacturer for further proceedings if the battery is fully discharged.

DANGER

Danger to life due to burns caused by electric arcs through short-circuit currents!

Short-circuit currents in the battery can cause heat accumulation and electric arcs if the battery is short circuited or wrongly installed. Heat accumulation and electric arcs may result in lethal injuries due to burns.

- Disconnect the battery from all voltages sources prior to performing any work on the battery.
- Only use properly insulated tools to prevent accidental electric shock or short circuits during installation.
- Observe all safety information of the battery manufacturer.

DANGER

Danger to life due to electric shock when touching live system components in case of a ground fault!

If a ground fault occurs, parts of the system may still be live. Touching live parts and cables may result in death or lethal injuries due to electric shock.

- Disconnect the product from voltage and energy sources and ensure it cannot be reconnected before working on the device.
- Only touch the cables of the PV modules on their insulation.
- Do not touch any parts of the substructure or frame of the PV array.
- Do not connect PV strings with ground faults to the product.

WARNING

Danger to life due to electric shock from destruction of the measuring device due to overvoltage!

Overvoltage can damage a measuring device and result in voltage being present in the enclosure of the measuring device. Touching the live enclosure of the measuring device results in death or lethal injuries due to electric shock.

- Only use measuring devices with the measurement span higher than the DC input voltage range equal to or higher than the voltage rating of the product.

CAUTION

Risk of burns due to high temperature.

Some parts of the enclosure can become hot during operation.

- During operation, do not touch any parts other than the enclosure lid of the product.

CAUTION

Risk of injury due to weight of product.

Injuries may result if the product is lifted incorrectly or dropped while being transported or mounted.

- Transport and lift the product carefully. Take the weight of the product into account.
- Wear suitable personal protective equipment for all work on the product.

2.3 Symbols on the label



Beware of a danger zone!

This symbol indicates that the product must be additionally grounded if additional grounding or equipotential bonding is required at the installation site.



Beware of high voltage and operating current!

The inverter operates at high voltage and current. Work on the inverter must only be carried out by skilled and authorized electricians.



Beware of hot surfaces!

The inverter can get hot during operation. Avoid contact during operation.



WEEE designation

Do not dispose of the product together with the household waste but in accordance with the disposal regulations for electronic waste applicable at the installation site.



CE marking

The product complies with the requirements of the applicable EU directives.



Certification mark

The product has been tested by TUV and got the quality certification mark.



RCM (Regulatory Compliance Mark)

The product complies with the requirements of the applicable Australian standards.



Capacitor discharge

Danger to life due to high voltages in the inverter. Do not touch live parts for 5 minutes after disconnection from the power sources.



Observe the documentation

Observe all documentation supplied with the product.

3 System Wiring Diagram

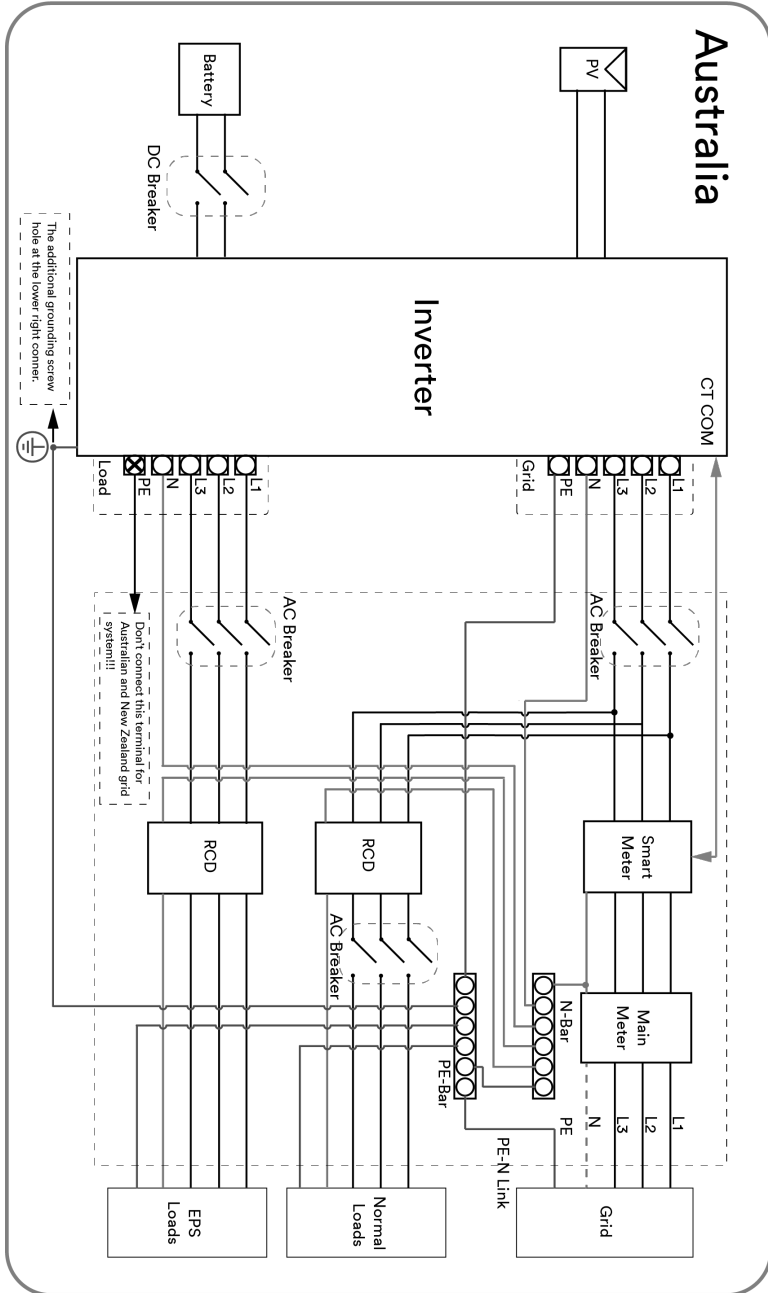

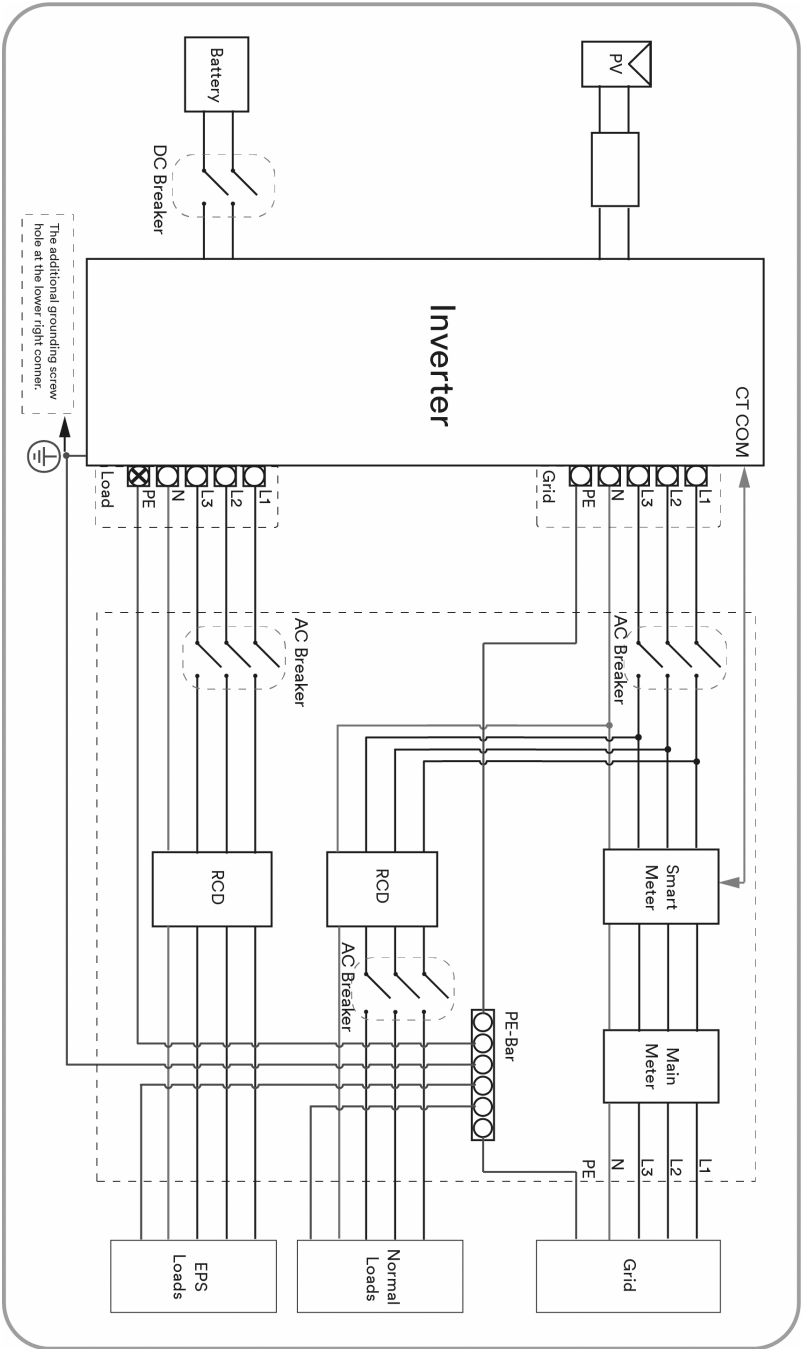

4 EU Declaration of Conformity

Within the scope of the EU directives

- Radio Equipment Directive 2014/53/EU (L 153/62-106. May 22. 2014) (RED)
- Restriction of the use of certain hazardous substances 2011/65/EU (L 174/88, June 8, 2011) and 2015/863/EU (L 137/10, March 31,2015) (RoHS)



AISWEI Technology Co., Ltd. confirms herewith that the products described in this document are in compliance with the fundamental requirements and other relevant provisions of the above mentioned directives. The entire EU Declaration of Conformity can be found at www.solplanet.net.

5 Overview

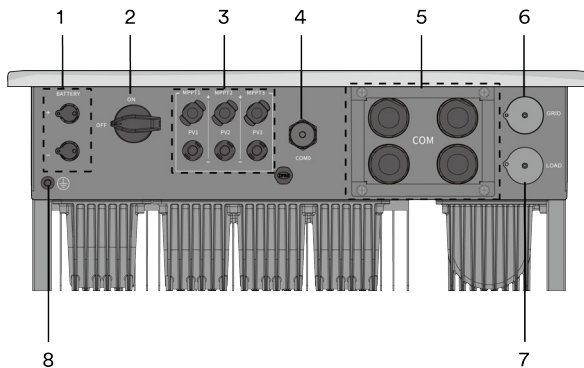

| Object | Description |
|--------|----------------------------|
| 1 | Battery Port |
| 2 | DC-switch |
| 3 | PV Input |
| 4 | Ai-Dongle |
| 5 | Communication ports |
| 6 | AC connector |
| 7 | EPS Load connector |
| 8 | Additional grounding screw |

6 Scope of Delivery

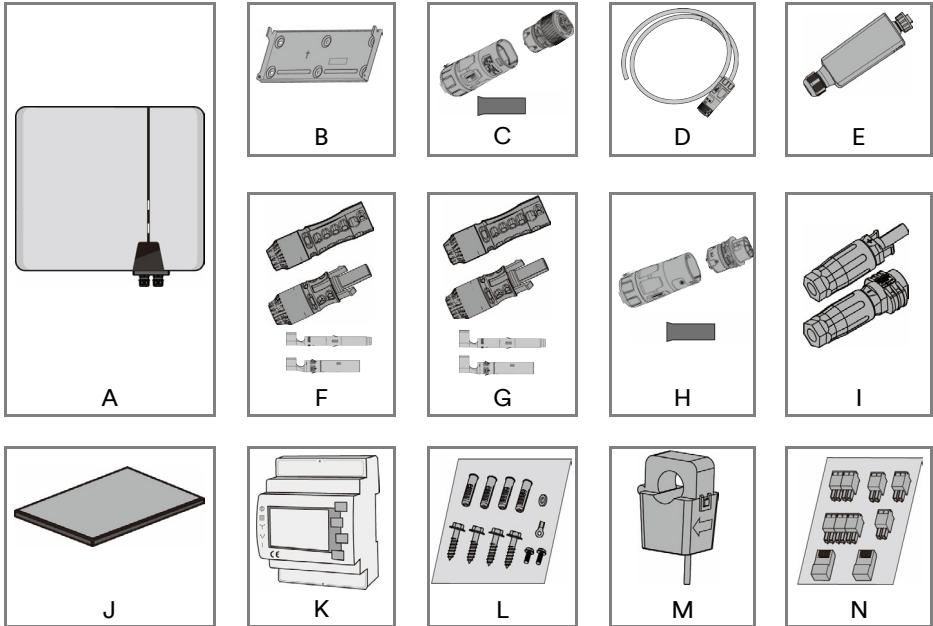

| Object | Description | Quantity | |
|--------|------------------------------------|-----------------------------|---|
| A | Inverter | 1 | |
| B | Wall Bracket | 1 | |
| C | AC connector | 1 | |
| | Terminal | 5 | |
| D | AC connector (10-12kH) | 1 | |
| E | Ai-Dongle(WLAN/LAN) | 1 | |
| F | Battery connector | Socket: PV-KBT4-EVO ST/6I | 1 |
| | | Plug: PV-KST4-EVO ST/6I | 1 |
| | Crimp contact (6mm ²) | PV-BP4-EVO 2/6 | 1 |
| | | PV-SP4-EVO 2/6 | 1 |
| G | Battery connector | Socket: PV-KBT4-EVO ST/10II | 1 |
| | | Plug: PV-KST4-EVO ST/10II | 1 |
| | Crimp contact (10mm ²) | PV-BP4-EVO 2/10 | 1 |
| | | PV-SP4-EVO 2/10 | 1 |

| | | | |
|---|--------------------------------|-----------------|---|
| H | EPS Load connector | ASW05-12kH-T2-O | 0 |
| | | ASW08-12kH-T3-O | |
| | Terminal | ASW05-12kH-T2 | 1 |
| | | ASW08-12kH-T3 | |
| I | DC connector | ASW05-12kH-T2 | 2 |
| | | ASW05-12kH-T2-O | |
| | | ASW08-12kH-T3 | 3 |
| | | ASW08-12kH-T3-O | |
| J | Document | 1 | |
| K | Smart meter | 1 | |
| L | Fastener package | 1 | |
| M | External CT | 3 | |
| N | Communication terminal package | 1 | |

7 Mounting Environment

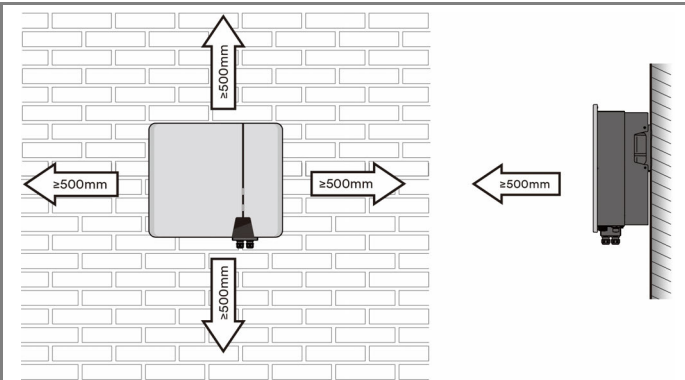
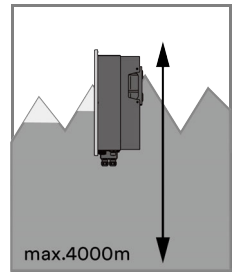
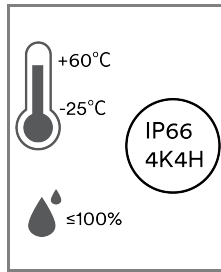
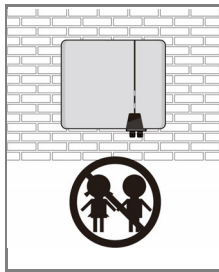
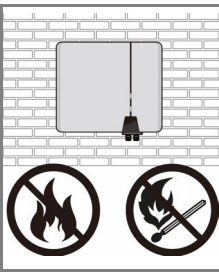
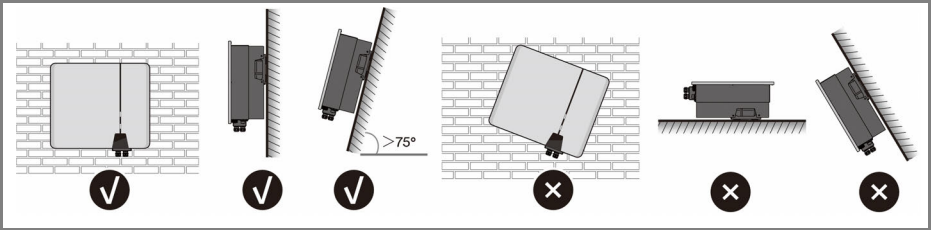
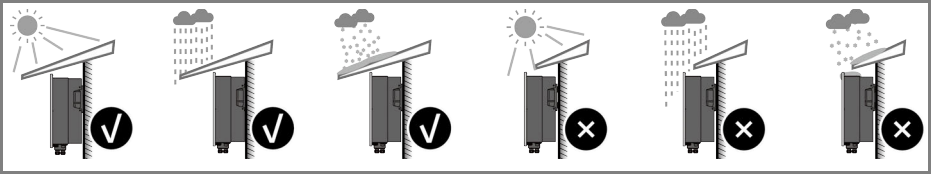

8 Dimensions

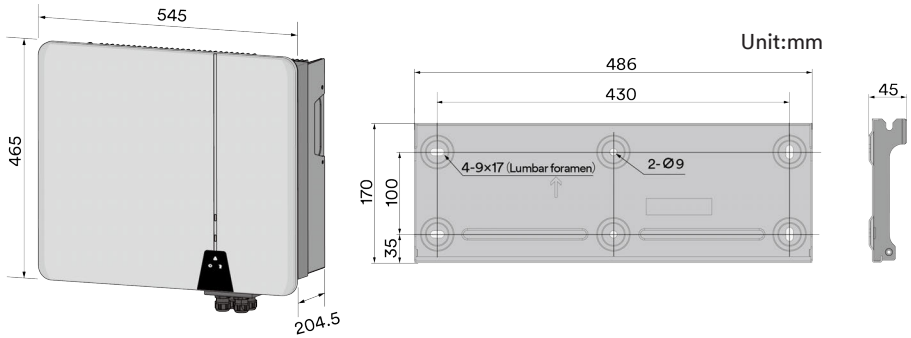

9 Mounting

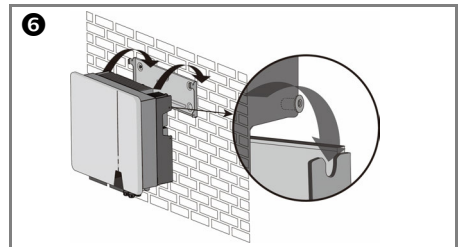
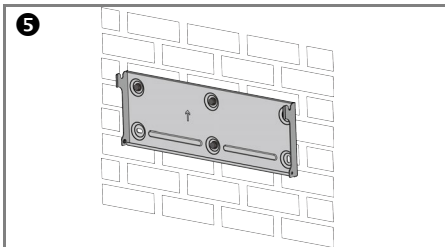
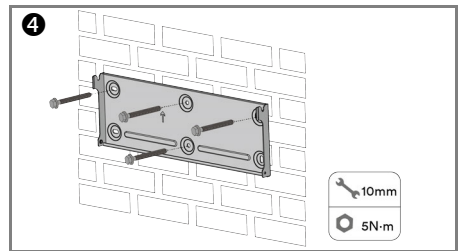
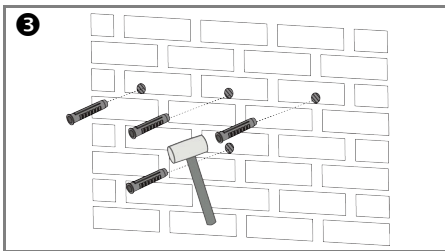
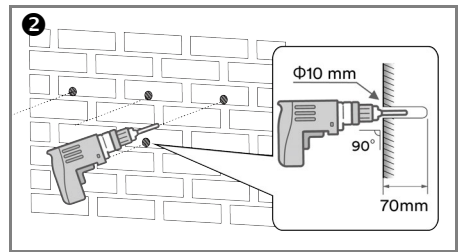
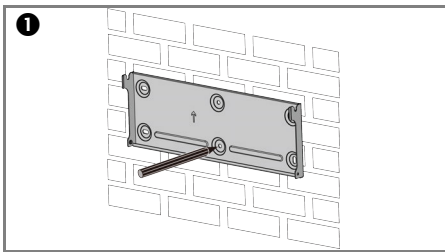

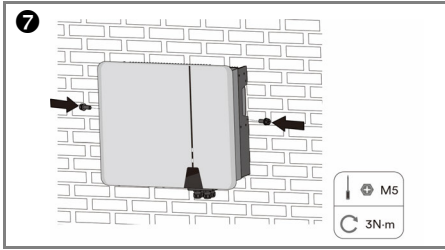



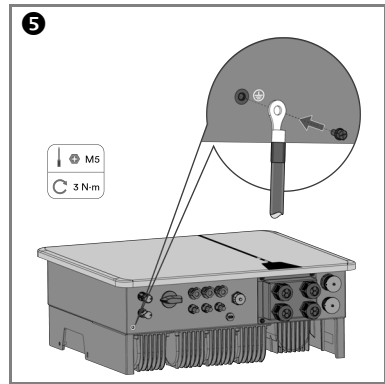
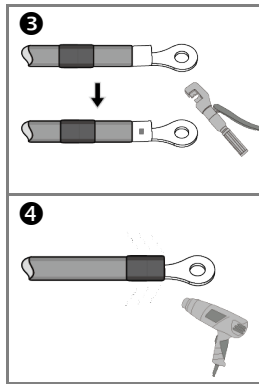
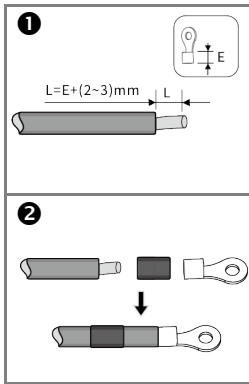



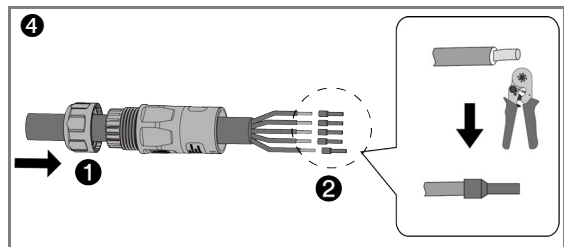
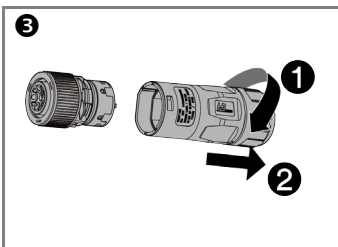
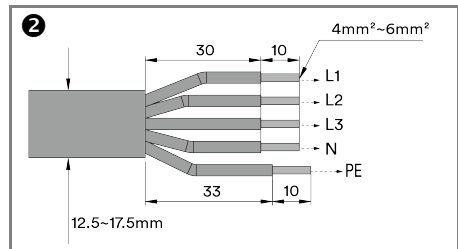
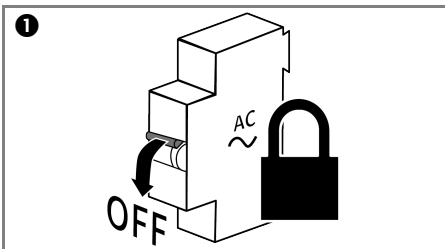

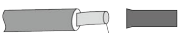
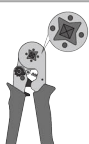

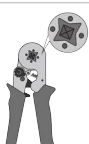



10 Second Protective Grounding

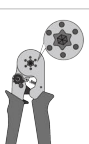

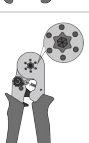
11 AC CONNECTION



| | | | |
|---|--|--|---|
| ✗ |  <p>4mm²</p> |  |  <p>4.5mm</p> |
| ✓ |  <p>6mm²</p> |  |  <p>4.09mm</p> |
| ✓ |  <p>4mm²</p> |  |  <p>3.38mm</p> |
| ✓ |  <p>4mm²</p> |  |  <p>3.64mm</p> |
| ✓ |  <p>6mm²</p> |  |  <p>3.92mm</p> |
| ✓ |  <p>4mm²</p> |  |  <p>3.10mm</p> |

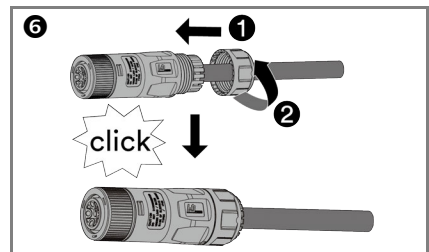
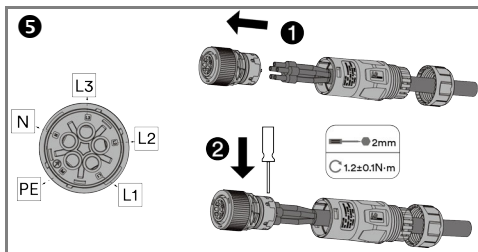
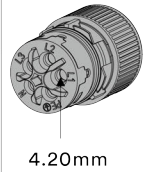

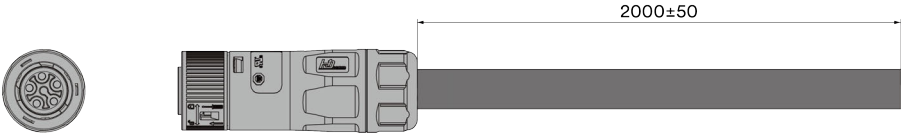
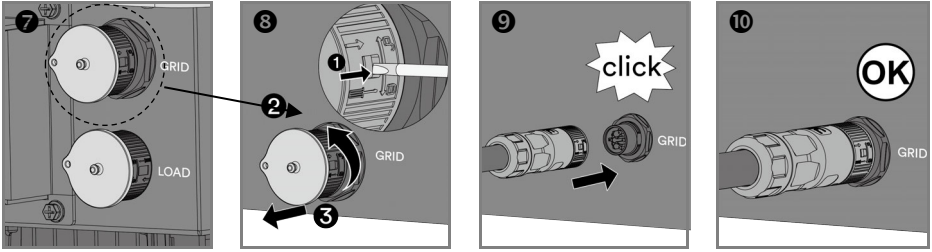

Unit:mm

| NO. | icon | Connector number | Line color |
|-----|------|------------------|--------------|
| 1 | | L1 | brown |
| 2 | | L2 | black |
| 3 | | L3 | grey |
| 4 | | N | blue |
| 5 | | PE | yellow-green |

12 EPS Load Connection

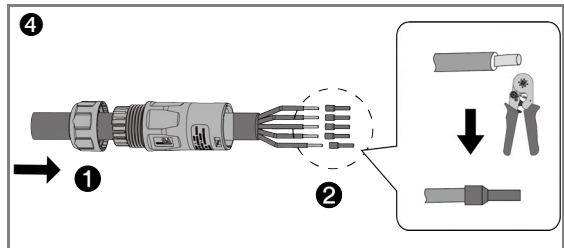
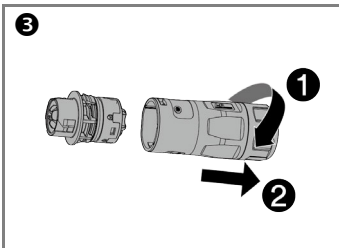
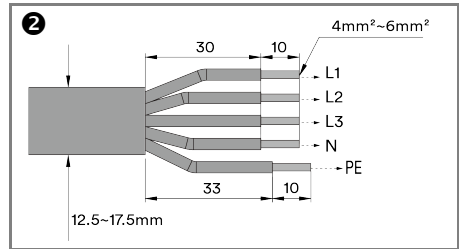
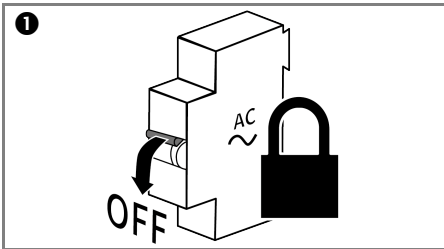

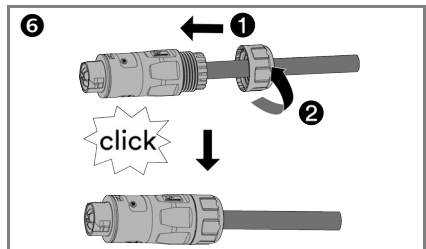
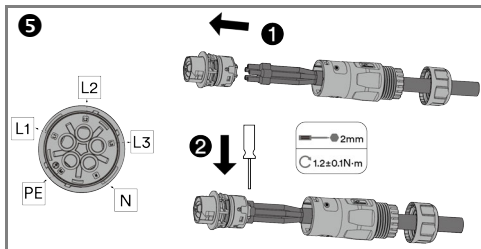
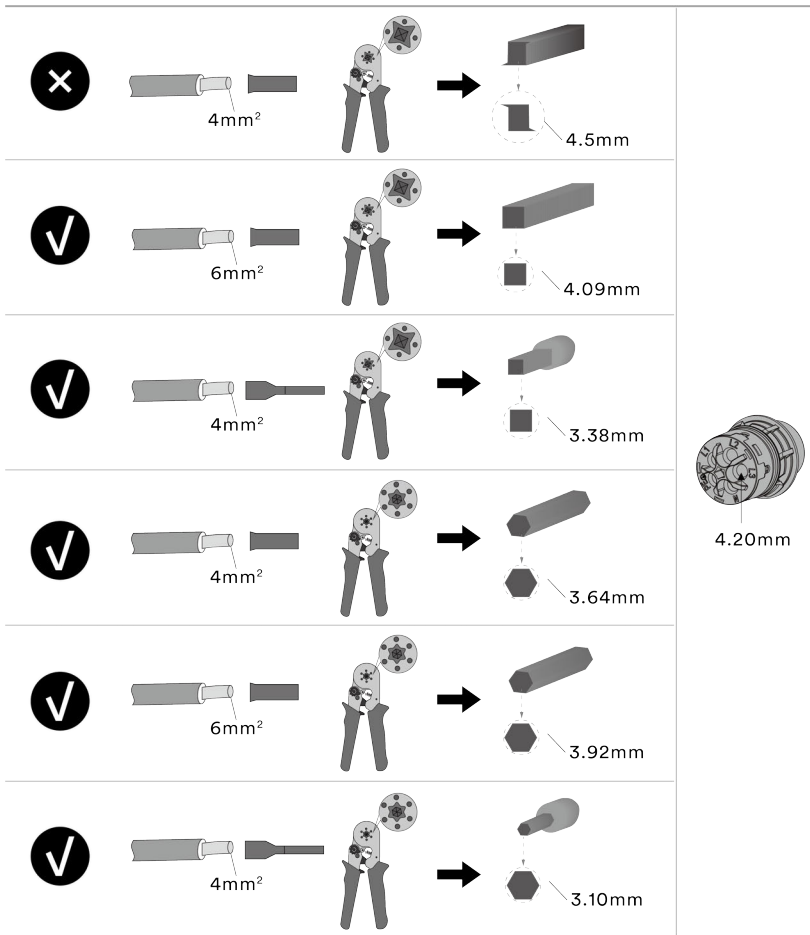

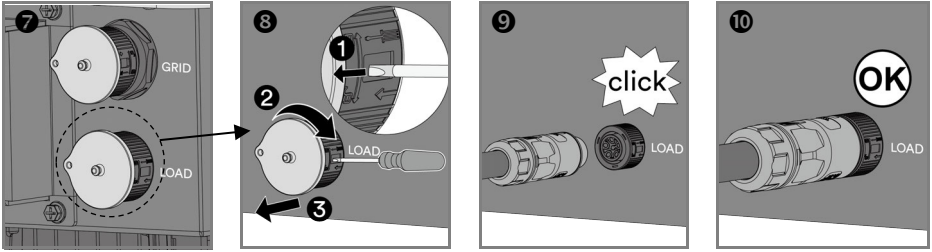

13 DC Connection

TYPE 1

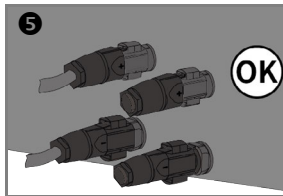
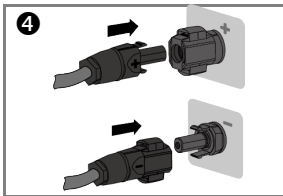
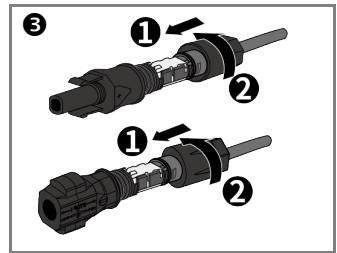
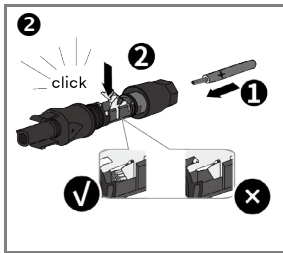
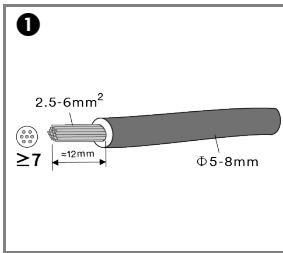

TYPE 2

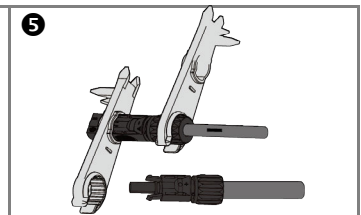
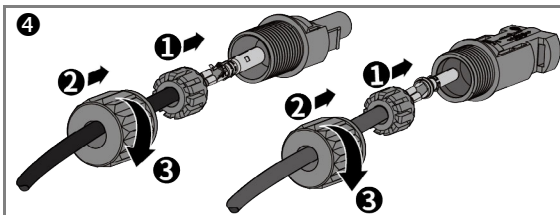
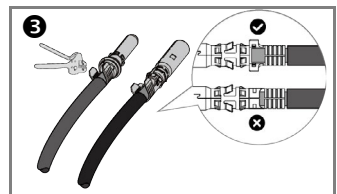
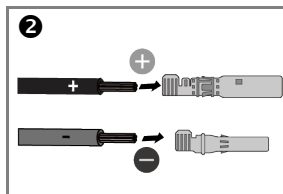
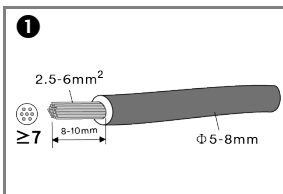

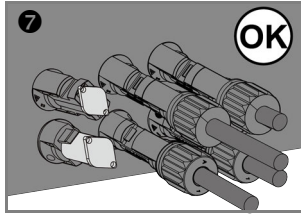
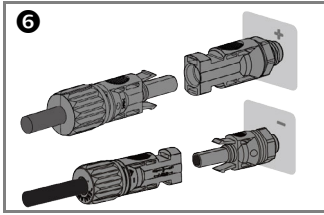

14 Battery Connection

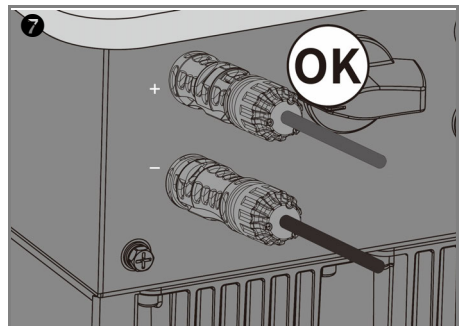
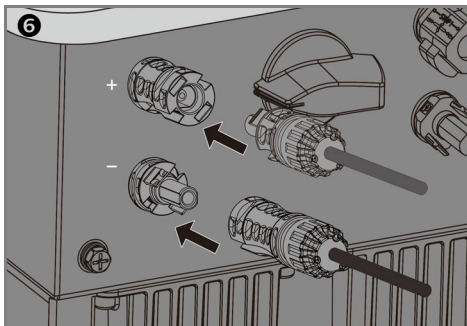
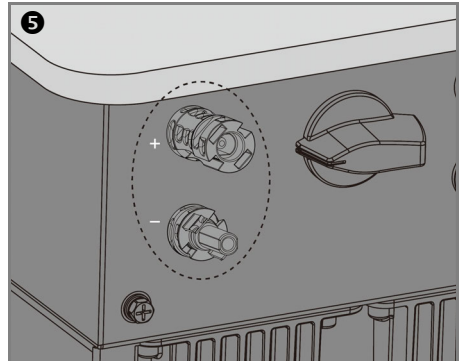
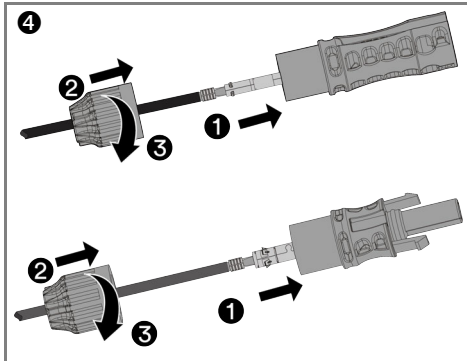
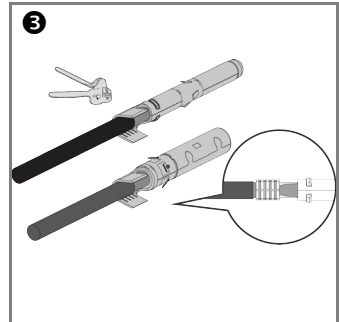
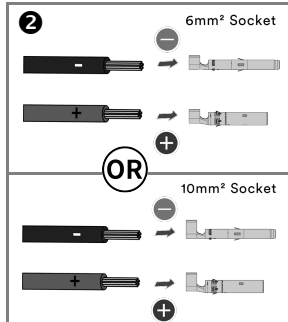
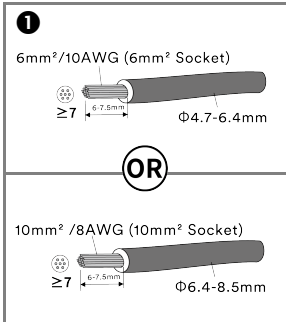

15 Communication Setup

15.1 Communication connection

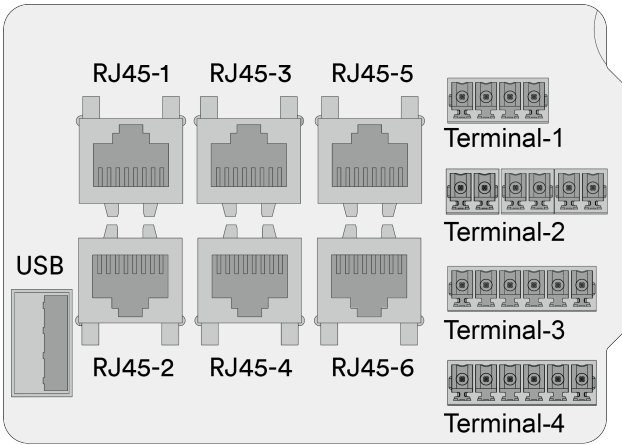
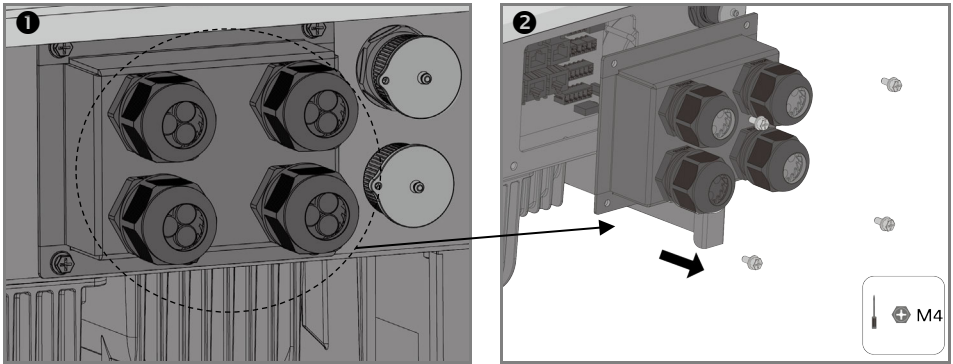

| Object | Description | Terminal | PIN definition | | | | | | | |
|---------|-------------|----------|----------------|--------|-----|-------|-------|---|--------|--------|
| | | | 1 | 2 | 3 | 4 | 5 | 6 | 7 | 8 |
| RJ-45-3 | Monitor | COM2 | RS485A | RS485B | GND | X | X | X | RS485A | RS485B |
| RJ-45-4 | BMS | COM5 | X | GND | X | CANAH | CANAL | X | RS485A | RS485B |

| Object | Description | Terminal | PIN definition | | | | | |
|------------|-------------|----------|----------------|--------|---|---|--|----------|
| | | | 1 | 2 | 3 | 4 | 5 | 6 |
| Terminal-2 | \ | 6pin | Smart Meter | | \ | | NS-protection (network and system protection) Device | |
| | | | RS485A | RS485B | | | Positive | Negative |

| Terminal-3 | DI*4/DRMO | 6pin | Ripple Control Receiver Device | | | | DRMS Device | |
|------------|-----------|------|--------------------------------|-------|------------------------------|-------|------------------------------|-------------------------|
| | | | DI_4 | DI_3 | DI_2 | DI_1 | REF GEN/O | COM LOAD/O or GND |
| Terminal-4 | CT | 6pin | Current Transformer L1(U) | | Current Transformer L2(V) | | Current Transformer L3(W) | |
| | | | Red | Black | Red | Black | Red | Black |

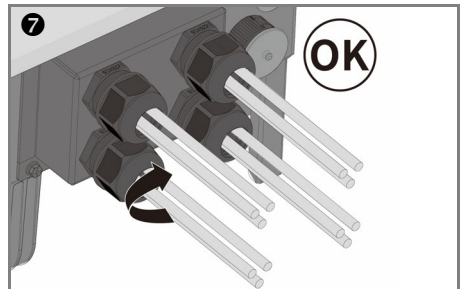
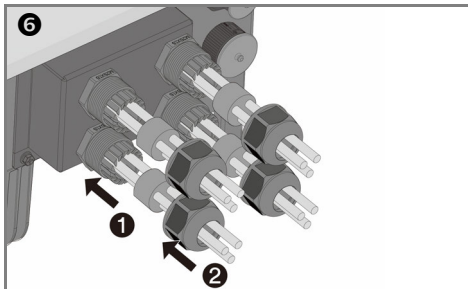
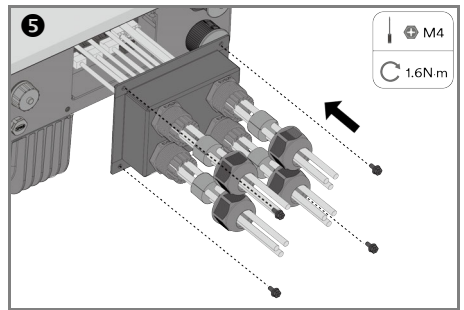
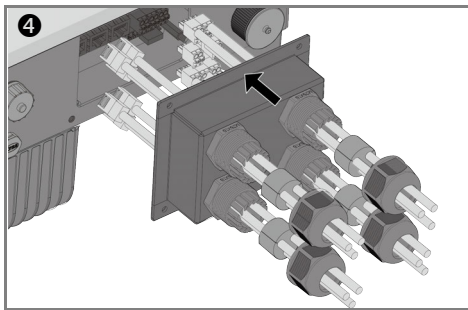
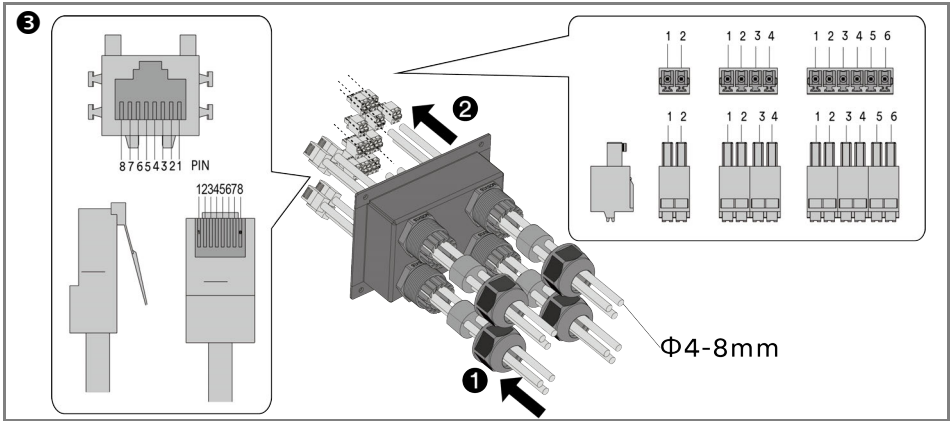

15.2 Current Transformer connection (optional)

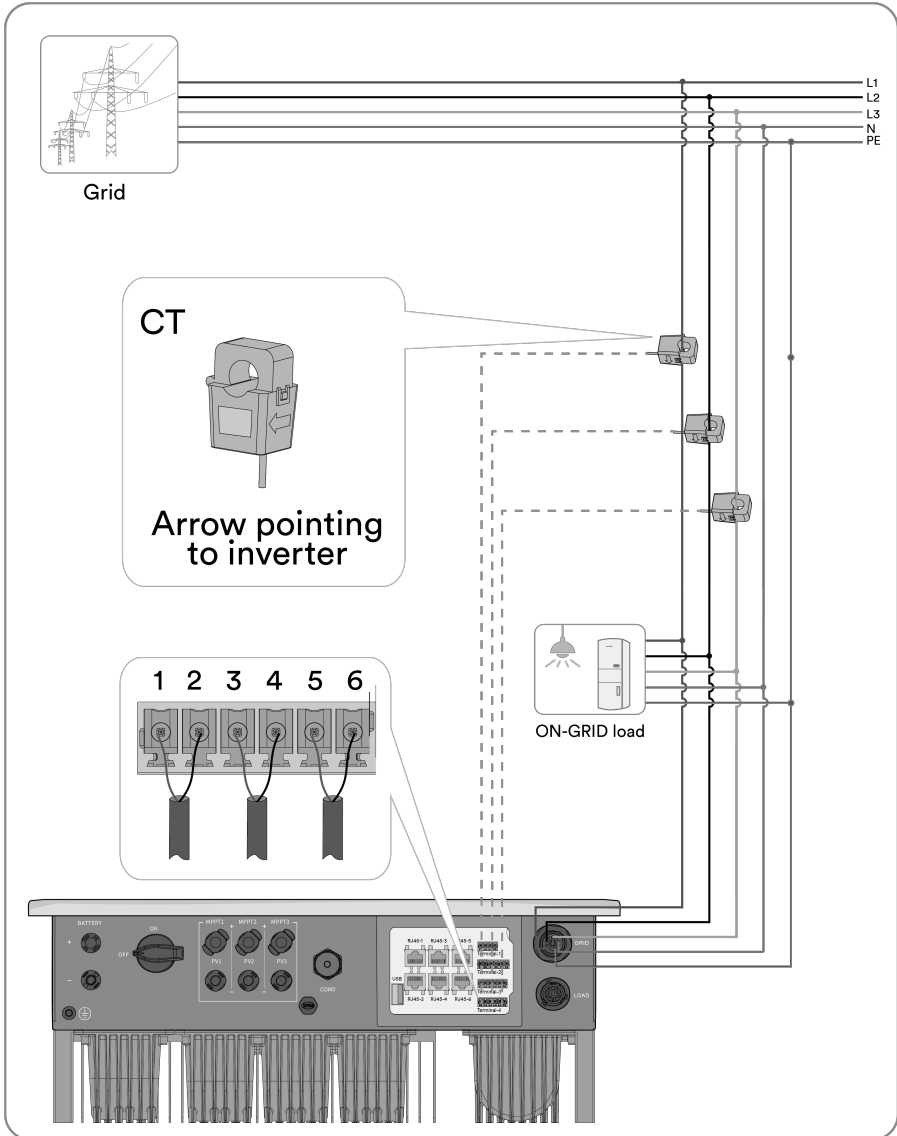

15.4 Ai-Dongle connection

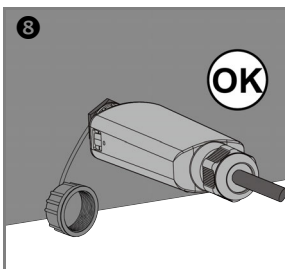
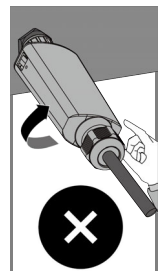
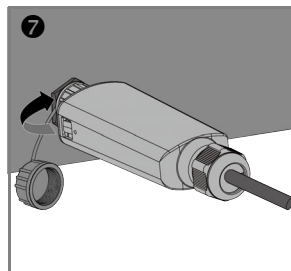
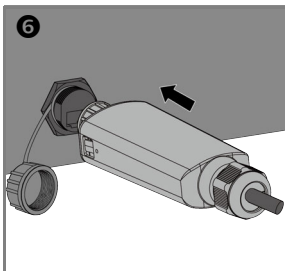
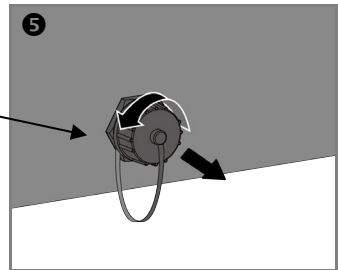
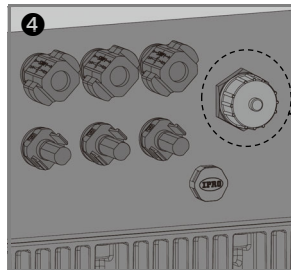
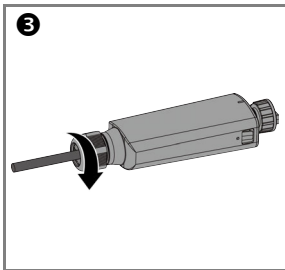
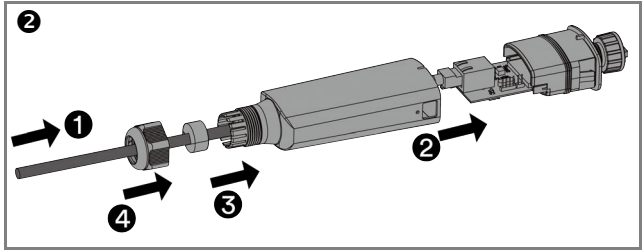
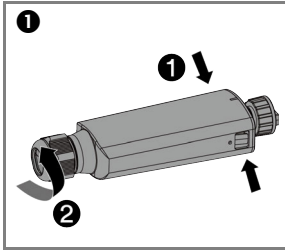

16 Contact

Please contact our Service Department if you have any technical questions about our products.

The following information is needed to provide necessary assistance:

- Inverter model
- Inverter serial number
- Photovoltaic module model
- Photovoltaic modules number and strings number connected to each MPPT
- Fault code
- Installation location

EMEA

Service email: service.EMEA@solplanet.net

APAC

Service email: service.APAC@solplanet.net

LATAM

Service email: service.LATAM@solplanet.net

Aiswei Greater China

Service email: service.china@aiswei-tech.com

Hotline: +86 400 801 9996

Taiwan

Service email: service.taiwan@aiswei-tech.com

Hotline: +886 809089212

<https://solplanet.net/contact-us>

Scan QR code:



Android

Scan QR code:



iOS

