

# User Manual

## 1-Phase PV Grid-Connected Inverter

SG2.0RS-S / SG2.5RS-S / SG3.0RS-S / SG3.0RS /  
SG3.6RS / SG4.0RS / SG5.0RS / SG6.0RS





# All Rights Reserved

## All Rights Reserved

No part of this document can be reproduced in any form or by any means without the prior written permission of Sungrow Power Supply Co., Ltd (hereinafter "SUNGROW").

## Trademarks

**SUNGROW** and other Sungrow trademarks used in this manual are owned by SUNGROW.

All other trademarks or registered trademarks mentioned in this manual are owned by their respective owners.

## Software Licenses

- It is prohibited to use data contained in firmware or software developed by SUNGROW, in part or in full, for commercial purposes by any means.
- It is prohibited to perform reverse engineering, cracking, or any other operations that compromise the original program design of the software developed by SUNGROW.

# About This Manual

The manual mainly contains the product information, as well as guidelines for installation, operation, and maintenance. The manual does not include complete information about the photovoltaic (PV) system. Readers can get additional information at [www.sungrowpower.com](http://www.sungrowpower.com) or on the webpage of the respective component manufacturer.

## Validity

This manual is valid for the following model of low-power grid-connected PV string inverters:

- SG2.0RS-S
- SG2.5RS-S
- SG3.0RS-S
- SG3.0RS
- SG3.6RS
- SG4.0RS
- SG5.0RS
- SG6.0RS

It will be referred to as "inverter" hereinafter unless otherwise specified.

## Target Group

This manual is intended for professional technicians who are responsible for installation, operation, and maintenance of inverters, and users who need to check inverter parameters.

The inverter must only be installed by professional technicians. The professional technician is required to meet the following requirements:

- Know electronic, electrical wiring and mechanical expertise, and be familiar with electrical and mechanical schematics.
- Have received professional training related to the installation and commissioning of electrical equipment.
- Be able to quickly respond to hazards or emergencies that occur during installation and commissioning.
- Be familiar with local standards and relevant safety regulations of electrical systems.
- Read this manual thoroughly and understand the safety instructions related to operations.

## How to Use This Manual

Please read this manual carefully before using the product and keep it properly at a place for easy access.

All contents, pictures, marks, and symbols in this manual are owned by SUNGROW. No part of this document may be reprinted by the non-internal staff of SUNGROW without written authorization.

Contents of this manual may be periodically updated or revised, and the actual product purchased shall prevail. Users can obtain the latest manual from [support.sungrowpower.com](http://support.sungrowpower.com) or sales channels.

### **Symbols**

This manual contains important safety instructions, which are highlighted with the following symbols, to ensure personal and property safety during usage, or to help optimize the product performance in an efficient way.

Please carefully understand the meaning of these warning symbols to better use the manual.

#### **DANGER**

**Indicates high-risk potential hazards that, if not avoided, may lead to death or serious injury.**

#### **WARNING**

**Indicates moderate-risk potential hazards that, if not avoided, may lead to death or serious injury.**

#### **CAUTION**

**Indicates low-risk potential hazards that, if not avoided, may lead to minor or moderate injury.**

#### **NOTICE**

**Indicates potential risks that, if not avoided, may lead to device malfunctions or financial losses.**



“NOTE” indicates additional information, emphasized contents or tips that may be helpful, e.g., to help you solve problems or save time.



# Contents

---

All Rights Reserved .....	I
About This Manual .....	II
<b>1 Safety Instructions .....</b>	<b>1</b>
1.1 Unpacking and Inspection .....	2
1.2 Installation Safety .....	3
1.3 Electrical Connection Safety .....	3
1.4 Operation Safety .....	5
1.5 Maintenance Safety .....	5
1.6 Disposal Safety .....	7
<b>2 Product Description .....</b>	<b>8</b>
2.1 System Introduction .....	8
2.2 Product Introduction .....	10
2.3 Symbols on Product .....	12
2.4 LED Panel .....	13
2.5 Circuit Diagram .....	14
2.6 Function Description .....	15
<b>3 Unpacking and Storage .....</b>	<b>19</b>
3.1 Unpacking and Inspection .....	19
3.2 Inverter Storage .....	19
<b>4 Mechanical Mounting .....</b>	<b>21</b>
4.1 Safety During Mounting .....	21
4.2 Location Requirements .....	22
4.2.1 Installation Environment Requirements .....	22
4.2.2 Carrier Requirements .....	24
4.2.3 Angle Requirements .....	24
4.2.4 Clearance Requirements .....	25
4.3 Installation Tools .....	25
4.4 Moving the Inverter .....	26
4.5 Installing Mounting-bracket .....	27
4.6 Installing the Inverter .....	28
4.7 Installing Optimizer(Optional) .....	31

<b>5</b>	<b>Electrical Connection</b>	<b>32</b>
5.1	Safety Instructions	32
5.2	Terminal Description	34
5.3	Electrical Connection Overview	35
5.4	External Protective Grounding Connection	37
5.4.1	External Protective Grounding Requirements	38
5.4.2	Connection Procedure	38
5.5	AC Cable Connection	39
5.5.1	AC Side Requirements	39
5.5.2	Assembling the AC Connector	40
5.5.3	Installing the AC Connector	42
5.6	DC Cable Connection	43
5.6.1	PV Input Configuration	45
5.6.2	Assembling the PV Connectors	46
5.6.3	Installing the PV Connectors	47
5.7	WiNet-S Connection	51
5.7.1	Ethernet Communication	52
5.7.2	WLAN Communication	54
5.8	Smart Meter Connection	54
5.9	DRM Connection	57
<b>6</b>	<b>Commissioning</b>	<b>61</b>
6.1	Inspection Before Commissioning	61
6.2	Powering on the System	61
6.3	App Preparation	62
6.4	Creating a Plant	62
6.5	Initializing the Device	70
6.6	Configuring the Plant	75
6.7	Optimizer Physical Layout (Optional)	79
<b>7</b>	<b>iSolarCloud App</b>	<b>80</b>
7.1	Brief Introduction	80
7.2	Installing App	80
7.3	Account Registration	81
7.4	Login	82
7.4.1	Requirements	82
7.4.2	Login Procedure	83
7.5	Initial Settings	85
7.6	Function Overview	85



7.7 Home .....	86
7.8 Run Information.....	87
7.9 Records.....	88
7.10 More.....	91
7.10.1 System Parameters.....	92
7.10.2 Operation Parameters .....	92
7.10.3 Power Regulation Parameters.....	93
7.10.4 Communication Parameters.....	98
7.10.5 Firmware Update .....	98
7.10.6 Auto-test.....	99
<b>8 System Decommissioning .....</b>	<b>101</b>
8.1 Disconnecting Inverter .....	101
8.2 Dismantling the Inverter .....	101
8.3 Disposal of Inverter.....	102
<b>9 Troubleshooting and Maintenance .....</b>	<b>103</b>
9.1 Troubleshooting .....	103
9.2 Maintenance .....	112
9.2.1 Maintenance Notices.....	112
9.2.2 Quick Shutdown.....	113
9.2.3 Routine Maintenance .....	114
<b>10 Appendix .....</b>	<b>115</b>
10.1 Technical Data.....	115
10.2 Quality Assurance .....	121
10.3 Contact Information .....	122



# 1 Safety Instructions

When installing, commissioning, operating, and maintaining the product, strictly observe the labels on the product and the safety requirements in the manual. Incorrect operation or work may cause:

- Injury or death to the operator or a third party.
- Damage to the product and other properties.

## WARNING

- **Do not perform any operation on the product (including but not limited to, handling, installing, powering on, or maintaining the product, performing electrical connection, and working at heights) in harsh weather conditions, such as thunder and lightning, rain, snow, and Level 6 or stronger winds. SUNGROW shall not be held liable for any damage to the device due to force majeure, such as earthquakes, floods, volcanic eruptions, mudslides, lightning strikes, fires, wars, armed conflicts, typhoons, hurricanes, tornadoes, and other extreme weathers.**
- **In case of fire, evacuate from the building or product area and call the fire alarm. Re-entry into the burning area is strictly prohibited under any circumstances.**

## NOTICE

- **Tighten the screws with the specified torque using tools when fastening the product and terminals. Otherwise, the product may be damaged. And the damage caused is not covered by the warranty.**
- **Learn how to use tools correctly before using them to avoid hurting people or damaging the device.**
- **Maintain the device with sufficient knowledge of this manual and use proper tools.**



- The safety instructions in this manual are only supplements and cannot cover all the precautions that should be followed. Perform operations considering actual onsite conditions.
- SUNGROW shall not be held liable for any damage caused by violation of general safety operation requirements, general safety standards, or any safety instruction in this manual.
- When installing, operating, and maintaining the product, comply with local laws and regulations. The safety precautions in this manual are only supplements to local laws and regulations.
- During the product transport, installation, wiring, maintenance, etc., the materials and tools prepared by users must meet the requirements of applicable local laws and regulations, safety standards, and other specifications. SUNGROW shall not be held liable for any damage to the product caused by the adoption of materials and tools that fail to meet the above-mentioned requirements.
- Operations on the product, including but not limited to, handling, installing, wiring, powering on, maintenance, and use of the product, must not be performed by unqualified personnel. SUNGROW shall not be held liable for any damage to the product resulting from operations done by unqualified personnel.
- Where the transport of the product is arranged by users, SUNGROW shall not be held liable for any damage to the product that is caused by users themselves or the third-party transport service providers designated by the users.
- SUNGROW shall not be held liable for any damage to the product caused by the negligence, intent, fault, improper operation, and other behaviors of users or third-party organizations.
- SUNGROW shall not be held liable for any damage to the product arising from reasons unrelated to SUNGROW.

## 1.1 Unpacking and Inspection

### WARNING

- **Check all safety signs, warning labels and nameplates on devices.**
- **The safety signs, warning labels and nameplates must be clearly visible and cannot be removed or covered before the device is decommissioned.**

### NOTICE

**After receiving the product, check whether the appearance and structural parts of the device are damaged, and check whether the packing list is consistent with the actual ordered product. If there are problems with the above inspection items, do not install the device and contact your distributor first. If the problem persists, contact SUNGROW in time.**

## 1.2 Installation Safety

### DANGER

- Make sure there is no electrical connection before installation.
- Before drilling, avoid the water and electricity wiring in the wall.

### CAUTION

Improper installation may cause personal injury!

- If the product supports hoisting transport and is hoisted by hoisting tools, no one is allowed to stay under the product.
- When moving the product, be aware of the product weight and keep the balance to prevent it from tilting or falling.

### NOTICE

Before operating the product, must check and ensure that tools to be used have been maintained regularly.

## 1.3 Electrical Connection Safety

### DANGER

- Before electrical connections, please make sure that the inverter is not damaged, otherwise it may cause danger!
- Before electrical connections, please make sure that the inverter switch and all switches connected to the inverter are set to "OFF", otherwise electric shock may occur!

### DANGER

The PV string will generate lethal high voltage when exposed to sunlight.

- Operators must wear proper personal protective equipment during electrical connections.
- Must ensure that cables are voltage-free with a measuring instrument before touching DC cables.
- Respect all safety instructions listed in relevant documents about PV strings.
- The inverter must not be connected to a PV string that requires positive or negative grounding.

**⚠ DANGER**

**Danger to life due to a high voltage inside the inverter!**

- **Be sure to use special insulation tools during cable connections.**
- **Note and observe the warning labels on the product, and perform operations strictly following the safety instructions.**
- **Respect all safety instructions listed in this manual and other pertinent documents.**

**⚠ WARNING**

**Damage to the product caused by incorrect wiring is not covered by the warranty.**

- **Electrical connection must be performed by professionals.**
- **All cables used in the PV generation system must be firmly attached, properly insulated, and adequately dimensioned.**

**⚠ WARNING**

- **Check the positive and negative polarity of the PV strings, and connect the PV connectors to corresponding terminals only after ensuring polarity correctness.**
- **During the installation and operation of the inverter, please ensure that the positive or negative poles of PV strings do not short-circuit to the ground. Otherwise, an AC or DC short-circuit may occur, resulting in equipment damage. The damage caused by this is not covered by the warranty.**
- **Do not connect any load between the inverter and the AC circuit breaker directly connected to it, so as to prevent the switch from tripping by mistake.**
- **Determine the specifications of AC switch strictly in compliance with the applicable local laws and regulations and safety standards or the recommendation by SUNGROW. Otherwise, the switch may not open in time in the event of something abnormal, which may then lead to safety incidents.**

**NOTICE**

**Comply with the safety instructions related to PV strings and the regulations related to the local grid.**

## 1.4 Operation Safety

### DANGER

When routing cables, ensure a distance of at least 30 mm between the cables and heat-generating components or areas to protect the insulation layer of cables from aging and damage.

When the product is working:

- Do not touch the product enclosure.
- It is strictly forbidden to plug and unplug any connector on the inverter.
- Do not touch any wiring terminal of the inverter. Otherwise, electric shock may occur.
- Do not disassemble any parts of the inverter. Otherwise, electric shock may occur.
- It is strictly forbidden to touch any hot parts of the inverter (such as the heat sink). Otherwise, it may cause burns.
- Do not connect or remove any battery. Otherwise, electric shock may occur.
- Do not connect or remove any PV string or any PV module in a string. Otherwise, electric shock may occur.
- If the inverter is equipped with a DC switch, do not operate it. Otherwise, it may cause device damage or personal injury.

## 1.5 Maintenance Safety

### DANGER

**Risk of inverter damage or personal injury due to incorrect service!**

- Before maintenance, disconnect the AC circuit breaker on the grid side and then the DC switch. If a fault that may cause personal injury or device damage is found before maintenance, disconnect the AC circuit breaker and wait until the night before operating the DC switch. Otherwise, a fire inside the product or an explosion may occur, causing personal injuries.
- After the inverter is powered off for 10 minutes, measure the voltage and current with professional instrument. Only when there is no voltage nor current can operators who wear protective equipment operate and maintain the inverter.
- Even if the inverter is shut down, it may still be hot and cause burns. Wear protective gloves before operating the inverter after it cools down.

**⚠ DANGER**

Touching the power grid or the contact points and terminals on the inverter connected to the power grid may lead to electric shock!

- The power grid side may generate voltage. Always use a standard voltmeter to ensure that there is no voltage before touching.

**⚠ CAUTION**

To prevent misuse or accidents caused by unrelated personnel, post prominent warning signs or demarcate safety warning areas around the product.

**NOTICE**

To avoid the risk of electric shock, do not perform any other maintenance operations beyond those described in this manual. If necessary, contact your distributor first. If the problem persists, contact SUNGROW. Otherwise, the losses caused is not covered by the warranty.

**NOTICE**

- If the paint on the inverter enclosure falls or rusts, repair it in time. Otherwise, the inverter performance may be affected.
- Do not use cleaning agents to clean the inverter. Otherwise, the inverter may be damaged, and the loss caused is not covered by the warranty.
- As the inverter contains no parts that can be maintained, never open the enclosure of the inverter or replace any internal components without authorization. Otherwise, the loss caused is not covered by the warranty.
- Do not open the maintenance door in rainy or snowy weather. If it is inevitable, take proper protective measures to avoid the ingress of rainwater and snow into the maintenance compartment; otherwise, the product's operation may be affected.
- Before closing the maintenance door, check whether there is any object left inside the maintenance compartment, such as screws, tools, etc.
- It is recommended for users to use cable sheathing to protect the AC cable. If the cable sheathing is used, make sure it is positioned inside the maintenance compartment.



## 1.6 Disposal Safety

 **WARNING**

**Please scrap the product in accordance with relevant local regulations and standards to avoid property losses or casualties.**

## 2 Product Description

### 2.1 System Introduction

The inverter is a transformerless 1-phase PV grid-connected inverter. As an integral component in the PV power system, the inverter is designed to convert the direct current power generated from the PV modules into grid-compatible AC current and feeds the AC current to the utility grid.

#### **⚠ WARNING**

- **The inverter must only be operated with PV strings with class II protection in accordance with IEC 61730, application class A. It is not allowed for the positive pole or the negative pole of the PV strings to be grounded. This can cause damage to the inverter.**
- **Do not connect any local load between the inverter and the AC circuit breaker.**

#### **NOTICE**

**The inverter applies only to the scenarios described in this manual.**

The PV modules in the system must comply with the IEC 61730-1 (2016) class II standard. The intended usage of the inverter is illustrated in the following figure.

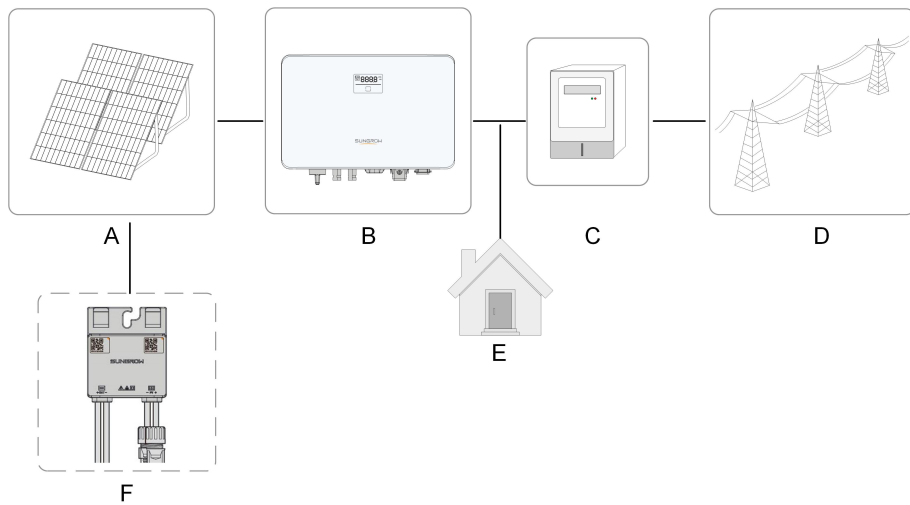

**figure 2-1** Inverter Application in PV Power System

Item	Description	Note
A	PV strings	Compatible with monocrystalline silicon, polycrystalline silicon, and thin-film modules without grounding.
B	Inverter	SG2.0RS-S, SG2.5RS-S, SG3.0RS-S, SG3.0RS, SG3.6RS, SG4.0RS, SG5.0RS, SG6.0RS.
C	Metering device	Meter cupboard with power distribution system.
D	Utility grid	TT , TN-C , TN-S, TN-C-S.
E	Loads	House loads that consume electricity.
F	Optimizer	/

Please refer to the optimizer user manual for details.



Please contact your local sales staff to confirm that the optimizer is available for sale in your territory. SP600S optimizer is not compatible with third-party products.

The following figure shows the common grid configurations.

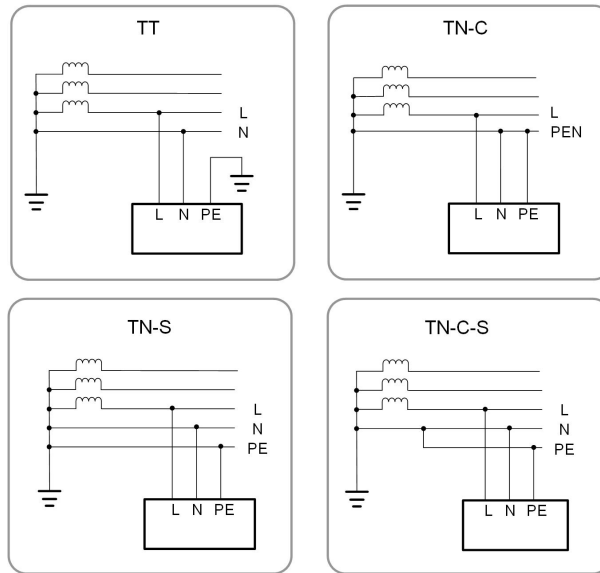

S005-G002

To meet the demand of users in different regions, connection to a split-phase grid system is supported for this inverter, as in the following way. Grounding detection function will not be available when the inverter is used in the split-phase grid system.

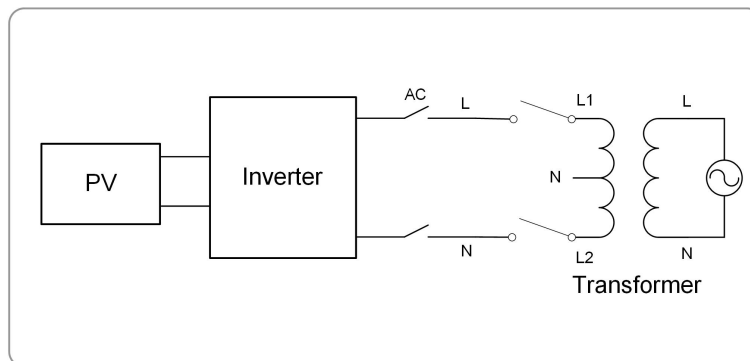

## 2.2 Product Introduction

### Model Description

The model description is as follows (take SG3.0RS-S as an example):

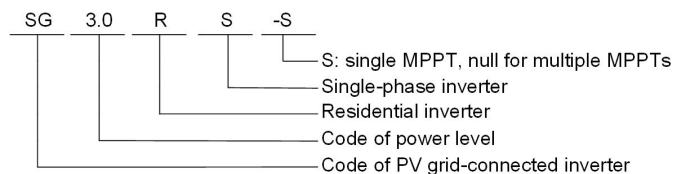

S005-G003

## Appearance

The following figure shows the appearance of the inverter. The image shown here is for reference only. The actual product received may differ.

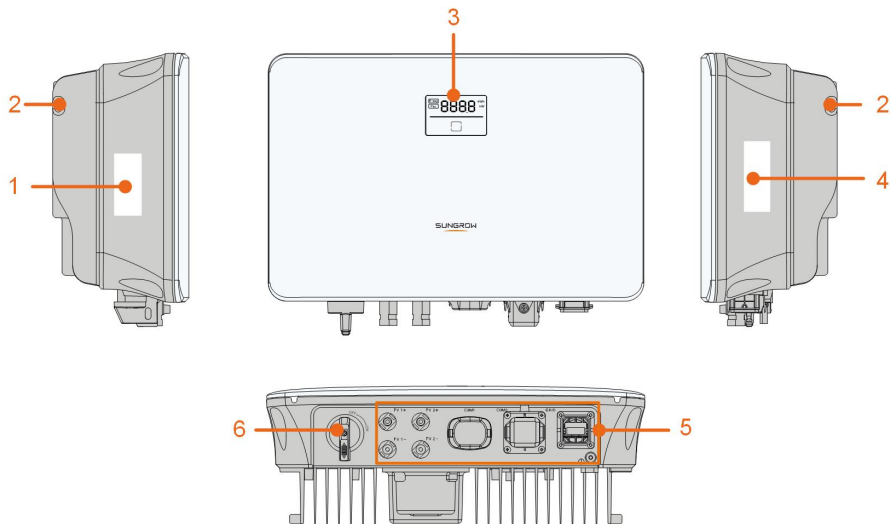

S005-G004

**figure 2-2** Inverter Appearance

No.	Name	Description
1	Label	Information about <b>COM2</b> pin definition, supported DRM modes, etc.
2	Hanger	Complement to the included wall mounting bracket for hanging the inverter.
3	LED panel	The LED screen indicates the running information and the LED indicator indicates the working state of the inverter.
4	Nameplate	To clearly identify the product, including device model, S/N, important specifications, marks of certification institutions, etc.
5	Electrical connection area	DC terminals (SG6.0RS for example), AC terminal, external grounding terminal and communication terminals.
6	DC switch	To safely disconnect the DC circuit whenever necessary.

## Dimensions

The following figure shows the dimensions of the inverter.

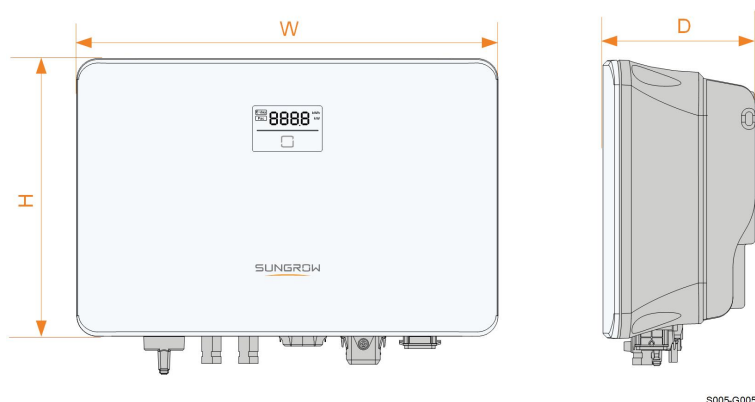





figure 2-3 Dimensions of the Inverter

Inverter Model	W (mm)	H (mm)	D (mm)
SG2.0RS-S, SG2.5RS-S, SG3.0RS-S	320	225	120
SG3.0RS, SG3.6RS, SG4.0RS, SG5.0RS, SG6.0RS	410	270	150

## 2.3 Symbols on Product

Symbol	Explanation
	Parameters on the DC side.
	Parameters on the AC on-grid side.
	Regulatory compliance mark.
	TÜV mark of conformity.
	CE mark of conformity. EU/EEA Importer.
	UKCA mark of conformity.
	Do not dispose of the inverter together with household waste.
	The inverter does not have a transformer.
	Disconnect the inverter from all the external power sources before maintenance!

Symbol	Explanation
	Read the user manual before maintenance!
	Burn danger due to the hot surface that may exceed 60°C.
	Danger to life due to high voltages! Do not touch live parts for 10 minutes after disconnection from the power sources. Only qualified personnel can open and maintain the inverter.
	External protective grounding terminal.

\* The table shown here is for reference only. The actual product received may differ.

## 2.4 LED Panel

The LED panel with a display screen and an indicator is on the front of the inverter.

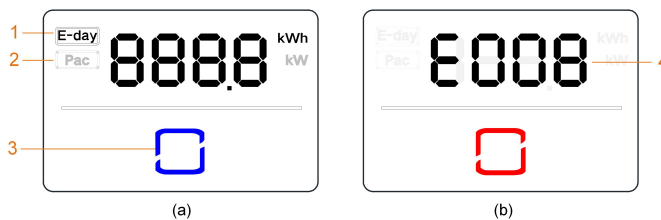

figure 2-4 LED Panel



(a) Normal state

(b) Error state

No.	Name	Description
1	E-day	Today's energy yield.
2	Pac	Current AC power.
3	LED indicator	To indicate the working state of the inverter. Touch it to switch the information in normal state or view multiple error codes in error state.
4	Error code	The error code in the figure is just an example.

- In normal state, the E-day and Pac information will be displayed alternately. Also you can touch the LED indicator to switch the information.
- In error state, touch the LED indicator to view error codes.
- If there is no operation for 5 minutes, the display screen will be off. Touch the LED indicator to activate it.

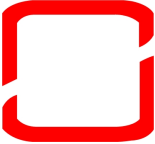
table 2-1 State description of the LED indicator

LED color	State	Definition
	On	The inverter is operating normally.
Blue	Flashing	The inverter is at standby or startup state (not feeding power into the grid).
	On	A system fault has occurred.
Red	Off	Both the AC and DC sides are powered down.
	Off	Both the AC and DC sides are powered down.
Gray		

**WARNING**

Voltage may still be present in AC side circuits after the indicator is off. Pay attention to the electricity safety during operating.

## 2.5 Circuit Diagram

The following figure shows the main circuit of the inverter.

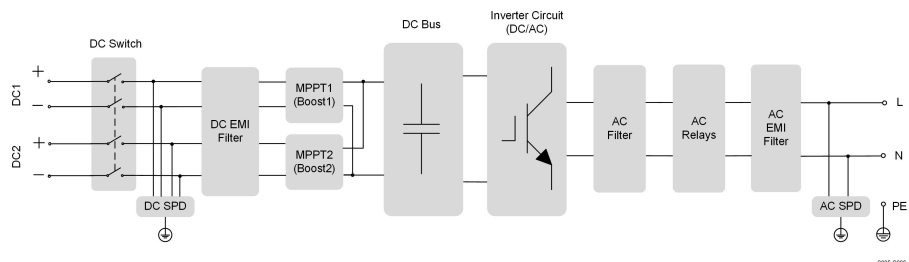

figure 2-5 Circuit Diagram (SG6.0RS for example)

- DC Switches can safely disconnect the PV input when necessary to ensure the safe operation of the inverter and the safety of personnel.
- The DC SPD provides a discharge circuit for the DC side overvoltage to prevent it from damaging the internal circuits of the inverter.
- EMI filters can filter out the electromagnetic interference inside the inverter to ensure that the inverter meets the requirements of electromagnetic compatibility standards.



- The MPPT is used to ensure a maximum power from PV arrays at different PV input conditions.
- The Inverter Circuit converts the DC power into grid-compliant AC power and feeds it into the grid.
- The AC filter filters the output AC component of high frequency to ensure that the output current meets the grid requirements.
- The AC relay isolates the AC output of the inverter from the grid, making the inverter safe from the grid in case of inverter failure or grid failure.
- The AC SPD provides a discharge circuit for the AC side overvoltage to prevent it from damaging the internal circuits of the inverter.

**⚠ DANGER**

**If the lightning level exceeds the protection level of the product, surge protection and overvoltage protection may fail, resulting in electric shock and fatal injury!**

## 2.6 Function Description

### Basic Function

- Conversion function

The inverter converts the DC power from the PV array to the AC power, in conformity with the grid requirements.

- Data storage

The inverter logs running information, error records, etc.

- Parameter configuration

The inverter provides various parameter configurations for optimal operation. Parameters can be set via the iSolarCloud App or the cloud server.

- Communication interface

The inverter is equipped with two communication interfaces. The communication device can be connected to the inverter via both interfaces.

After communication connection is established, users can view inverter information, operational data and can set inverter parameters through the iSolarCloud.



It is recommended to use the communication module from SUNGROW. Using a device from other companies may lead to communication failure or other unexpected damage.

- Protection Function

Several protective functions are integrated in the inverter, including short circuit protection, grounding insulation resistance monitoring, residual current protection, grid monitoring, DC overvoltage/overcurrent protection, etc.

### **DRM ("AU"/"NZ")**

The DRM function is only applicable to a single inverter.

The inverter provides terminals for connecting to a Demand Response Enabling Device (-DRED). After the connection, the DRED asserts demand response modes (DRMs). The inverter detects and initiates a response to all supported demand response modes listed in the following table.

table 2-2 Demand Response Mode Explanation

<b>Mode</b>	<b>Explanation</b>
DRM0	The inverter is in the state of shutdown.

### **Feed-in Limitation**

Set the feed-in limitation value via iSolarCloud App. When the smart energy meter detects that the export power is greater than the limit value, the inverter will reduce the output power within the specified range.

### **PID Zero**

The PID Zero function is applicable for both PV and DC-coupled PV plus storage systems. It can suppress PID during the day and intelligently repair PV panels damage caused by PID at night, by relieving or alleviating PV array voltage bias to PV-.

The traditional inverter needs boost circuit to extend the efficient generation time during the day, and break the symmetry of the PV array to the ground voltage, making it closer to the negative electrode. In addition, if the traditional inverter runs at night, the PV array to ground voltage is always limited to the lowest voltage point of the system, which increases the risk of PID.

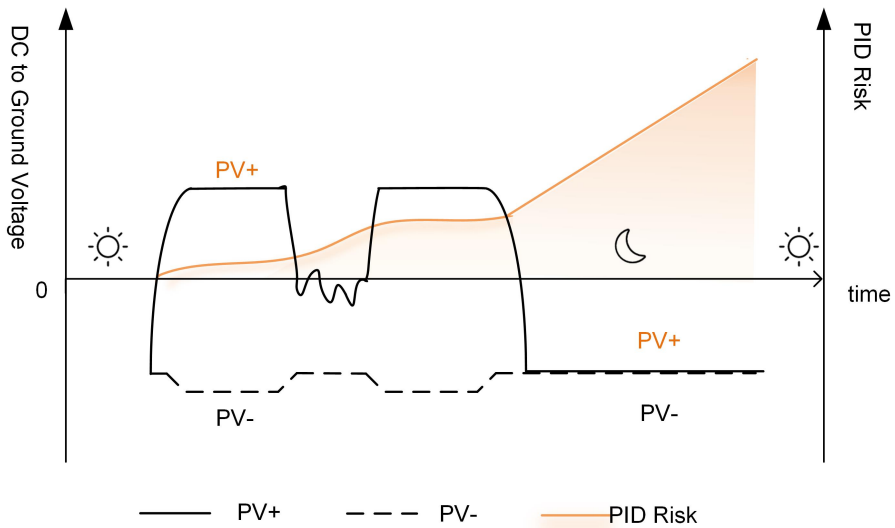

figure 2-6 PID Risk of Traditional Inverters

The following figure is the PID risk of the inverter equipped with PID Zero, it prevents the PV array voltage from approaching PV-, reduces the risk of PID during daily operation and repairs PV panels caused by PID at night. Details can be found in the *PID Zero White Paper*, which can be obtained on [www.sungrowpower.com](http://www.sungrowpower.com) or from your distributor.

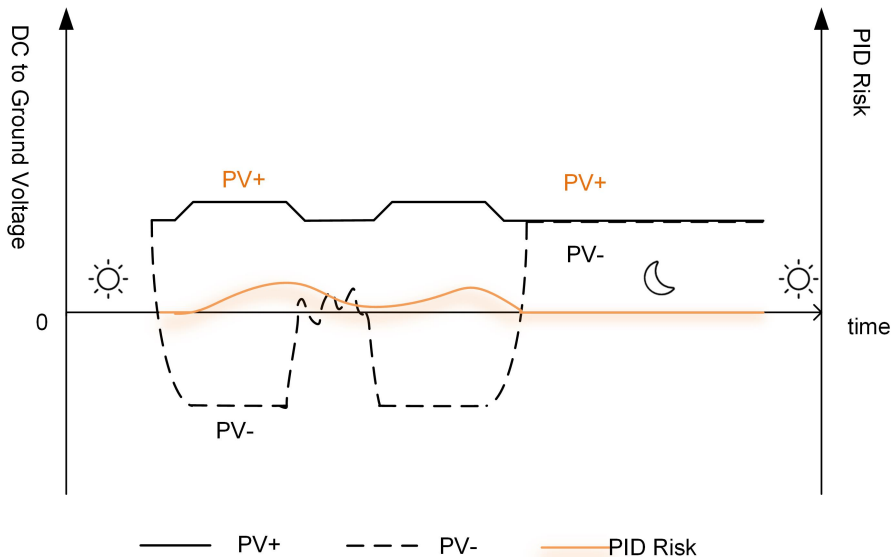

figure 2-7 PID Risk of Inverters Equipped with PID Zero

**⚠ DANGER**

**Keep the DC switch "ON" in the PID Zero process. During the process, there is voltage hazard between inverter / PV panels live conductors and ground. Do not touch any of them.**



- When the PID Zero function is enabled, there will be a power consumption of less than 30 W in the PID Zero process.
- PID Zero can be applied to P-type PV panels, as well as N-type PV panels of which the voltage between PV- and ground needs to be raised. Please disable this function for N-type PV panels of which the voltage between PV- and ground needs to be lowered. Contact the N-type PV panel supplier whether the voltage between PV- and ground needs to be raised for PID recovery.

### **AFCI Function(Optional)**

- AFCI activation

This function can be enabled to detect whether arc occurs in the DC circuit of the inverter.

- AFCI self-test

This function is intended to detect whether the AFCI function of the inverter is normal.



The arc detection function meets the standard requirements, please test under the working conditions as required by the standard.

### **Earth Fault Alarm**

The device gives an alarm if there is a grounding fault. If the AC side is poorly grounded or not grounded, the buzzer rings, and the LED indicator turns red.

### **Optimizer Functions**

- Module-level MPPT

Increase the power generation of the PV system by continuously tracking the maximum power point of the PV module.

- Module-level shutdown

Quickly reduce module voltage.

- Module-level monitoring

The optimizer can monitor the performance of modules.

- Module-level IV curve diagnosis

The optimizer can scan the module IV curve and judge whether a module fault occurs.

## 3 Unpacking and Storage

### 3.1 Unpacking and Inspection

The product is thoroughly tested and strictly inspected before delivery. Nonetheless, damage may still occur during shipping. For this reason, please conduct a thorough inspection after receiving the product.

- Check the packing case for any visible damage.
- Check the scope of delivery for completeness according to the packing list.
- Check the inner contents for damage after unpacking.

Contact SUNGROW or the transport company in case of any damage or incompleteness, and provide photos to facilitate services.

Do not dispose of the original packing case. It is recommended to store the device in the original packing case when the product is decommissioned.

#### NOTICE

- **After receiving the product, check whether the appearance and structural parts of the device are damaged, and check whether the packing list is consistent with the actual ordered product. If there are problems with the above inspection items, do not install the device and contact your distributor first. If the problem persists, contact SUNGROW in time.**
- **If any tool is used for unpacking, be careful not to damage the product.**

### 3.2 Inverter Storage

Proper storage is required if the inverter is not installed immediately.

- Store the inverter in the original packing case with the desiccant inside.
- The storage temperature must be always between  $-30^{\circ}\text{C}$  and  $+70^{\circ}\text{C}$ , and the storage relative humidity must be always between 0 and 95 %, non-condensing.
- In case of stacking storage, the number of stacking layers should never exceed the limit marked on the outer side of the packing case.
- The packing case should be upright.
- If the inverter needs to be transported again, pack it strictly before loading and transporting it.
- Do not store the inverter in places susceptible to direct sunlight, rain, and strong electric field.

- Do not place the inverter in places with items that may affect or damage the inverter.
- Store the inverter in a clean and dry place to prevent dust and water vapor from eroding.
- Do not store the inverter in places with corrosive substances or susceptible to rodents and insects.
- Carry out periodic inspections. Inspection shall be conducted at least once every six months. If any insect or rodent bites are found, replace the packaging materials in time.
- If the inverter has been stored for more than a year, inspection and testing by professionals are required before it can be put into operation.

**NOTICE**

**Please store the inverter according to the storage requirements. Product damage caused by failure to meet the storage requirements is not covered by the warranty.**

## 4 Mechanical Mounting

### WARNING

Respect all local standards and requirements during mechanical installation.

### 4.1 Safety During Mounting

### DANGER

Make sure there is no electrical connection before installation.  
Before drilling, avoid the water and electricity wiring in the wall.

### WARNING

For specific requirements for the installation environment, see "[4.2.1 Installation Environment Requirements](#)". In case the environment where the device is installed does not meet the requirements, SUNGROW shall not be held liable for any property damage arising therefrom.

### CAUTION

Improper handling may cause personal injury!

- When moving the inverter, be aware of its weight and keep the balance to prevent it from tilting or falling.
- Wear proper protective equipment before performing operations on the inverter.
- The bottom terminals and interfaces of the inverter cannot directly contact the ground or other supports. The inverter cannot be directly placed on the ground.

### NOTICE

When installing devices, ensure that no device in the system causes it hard for the DC switch and the AC circuit breaker to act or hinders maintenance personnel from operating.

If drilling is required during installation:

- Wear goggles and protective gloves when drilling holes.
- Make sure to avoid the water and electricity wiring in the wall before drilling.
- Protect the product from shavings and dust.

## 4.2 Location Requirements

To a large extent, a proper installation location ensures safe operation, service life, and performance of the inverter.

- The inverter with protection rating IP65 can be installed both indoors and outdoors.
- The inverter should be installed at a height that allows easy viewing of the LED indicator panel, as well as easy electrical connection, operation and maintenance.

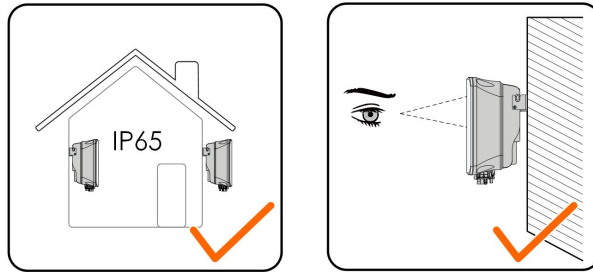

S005-I001

### 4.2.1 Installation Environment Requirements

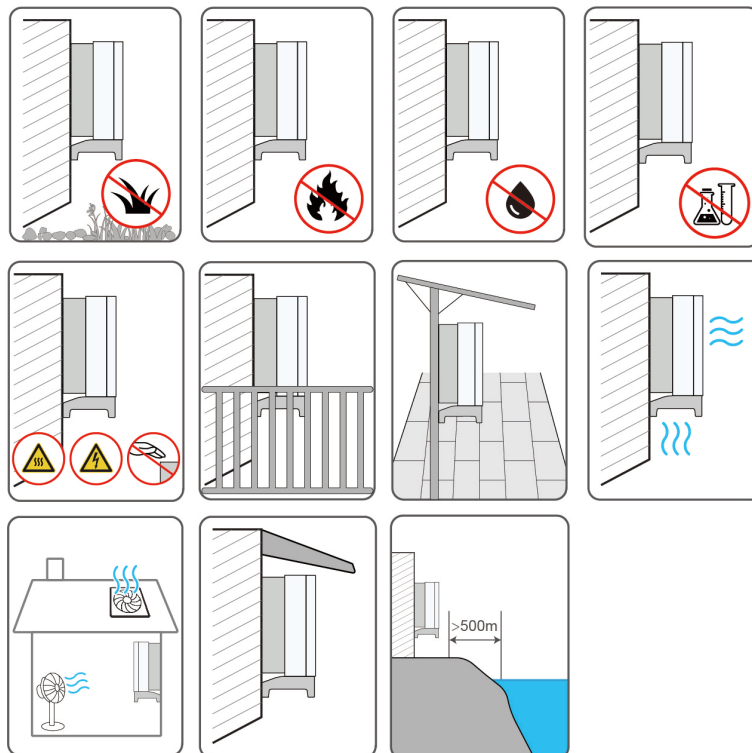

- If the inverter is installed in a place with lush vegetation, weed on a regular basis. In addition, the ground beneath the inverter needs to undergo certain treatment, such as laying cement or gravel, etc. (an area of 3m×2.5m is recommended).
- Do not install the inverter in an environment with flammables, explosives, or smoke.



- Do not install the inverter in places prone to water leak, e.g., under the air-conditioner vent, the air vent, or the cable outlet window of the machine room, so as to prevent device damage or short circuit caused by intrusion of water.
- Do not install the inverter in a place with corrosives such as corrosive gas and organic solvent, etc.
- When the inverter is running, its surface may carry high voltages or get very hot. Do not touch it; otherwise, it may lead to burns or electric shocks.
- Do not install the inverter in a place that is easy to reach for people.
- Install the inverter in a place with shelter, so as to prevent it from getting impacted by direct sunlight and severe weather (e.g. snow, rain, and lightning). The inverter will derate in high temperatures for self-protection. If installed in a place directly exposed to sunlight, as the temperature rises, the inverter may witness power reduction.
- Good heat dissipation is very important to the inverter. Please install the inverter in a ventilated environment.
- If the inverter needs to be installed in a closed environment, please install additional heat dissipation or ventilation devices. During the running of the inverter, the room temperature should not be higher than the outdoor ambient temperature.
- Please consult SUNGROW before installing inverters outdoors in areas prone to salt damage, which mainly are coastal areas within 500 meters of the coast. The sedimentation amount of salt spray is correlated to the characteristics of the seawater, sea winds, precipitation, air humidity, topography, and forest coverage in the adjacent sea areas, and there are substantial differences between different coastal areas.
- Do not install the inverter in an environment contaminated with chemicals such as halogen and sulfide.
- Do not install the inverter in an environment with vibration and strong electromagnetic field. Strong-magnetic-field environments refer to places where magnetic field strength measures over 30 A/m.
- In dusty environments such as places full of dust, smoke, or floc, particles may cling to the device's air outlet or heat sink, thus impacting its heat dissipation performance or even getting it damaged. Therefore, do not install the inverter in dusty environments. If the inverter has to be installed in such environments, please clean its fans and heat sink on a regular basis to ensure a good heat dissipation performance.
- The average temperature approximately 1 m around the inverter should be taken as its operating temperature. The temperature and humidity should meet the requirements below:

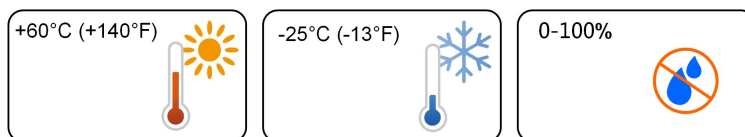

### 4.2.2 Carrier Requirements

The mounting structure where the inverter is installed must comply with local/national standards and guidelines. Ensure that the installation surface is solid enough to bear four times the weight of the inverter and is suitable for the dimensions of the inverter (e.g. cement walls, plasterboard walls, etc.).

Do not install the inverter on a carrier that may vibrate in resonance, so as to avoid making bigger noise.

The structure should meet the following requirements:

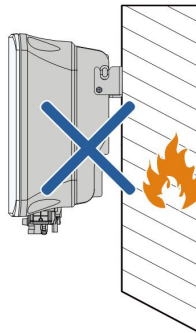

S005-1003

### 4.2.3 Angle Requirements

Install the inverter vertically. Never install the inverter horizontally, or at forward/backward tilted, side tilted, or upside down.

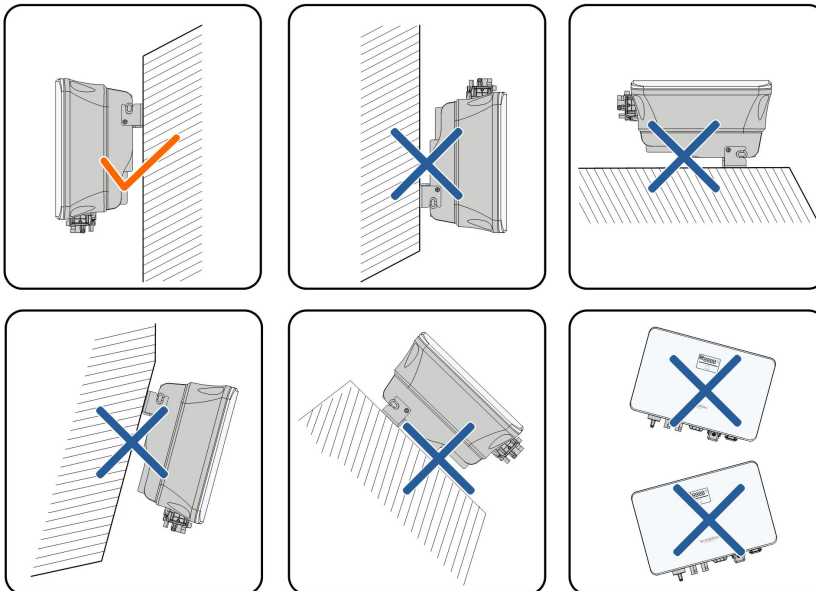

S005-1004

### 4.2.4 Clearance Requirements

Reserve enough clearance around the inverter to ensure sufficient space for heat dissipation.

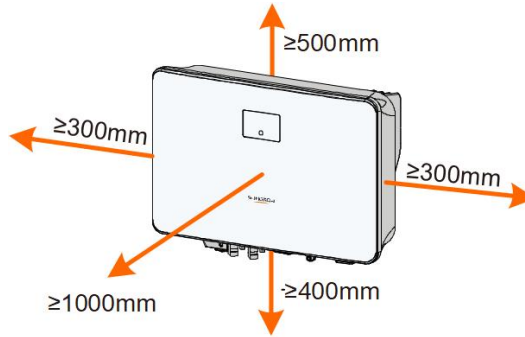







S0054005

Install the inverter at an appropriate height for ease of viewing the screen and LED indicator and operating switch(es).

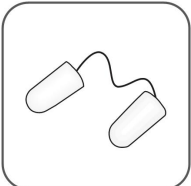
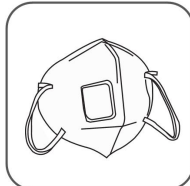
### 4.3 Installation Tools

Installation tools include but are not limited to the following recommended ones. If necessary, use other auxiliary tools on site.

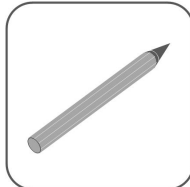
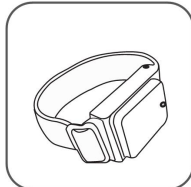
table 4-1 Tool specification

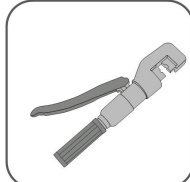
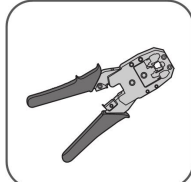
			
Goggles	Earplugs	Dust mask	Safety gloves
			
Safety shoes	Utility knife	Marker	Anti-static wrist strap
			

 <p>Wire cutter</p>	 <p>Wire stripper</p>	 <p>Hydraulic pliers</p>	 <p>RJ45 crimping tool</p>
 <p>OT terminal crimping tool (4 mm<sup>2</sup>–6 mm<sup>2</sup>)</p>	 <p>MC4 terminal crimping tool (0.5 mm<sup>2</sup>–1.0 mm<sup>2</sup>)</p>	 <p>Electric screwdriver (M4, M6)</p>	 <p>Slotted screwdriver (M2)</p>
 <p>Phillips screwdriver (M4)</p>	 <p>Vacuum cleaner</p>	 <p>Measuring tape</p>	 <p>Heat shrink tubing</p>
 <p>Heat gun</p>	 <p>Open-end wrench (33 mm, 35 mm)</p>	 <p>Connector wrench</p>	 <p>Multimeter (≥ 600 Vdc)</p>
 <p>Rubber mallet</p>	 <p>Hammer drill (φ10)</p>		

#### 4.4 Moving the Inverter

Before installation, remove the inverter from the packing case and move it to the installation site. Follow the instructions below as you move the inverter:

- Always be aware of the weight of the inverter.
- Lift the inverter using the handles positioned on both sides of the inverter.
- Move the inverter by one or two people or by using a proper transport tool.
- Do not release the equipment unless it has been firmly secured.

**⚠ CAUTION**

**Improper handling may cause personal injury!**

- **Arrange an appropriate number of personnel to carry the inverter according to its weight, and installation personnel should wear protective equipment such as anti-impact shoes and gloves.**
- **Attention must be paid to the center of gravity of the inverter to avoid tilting during handling.**
- **Placing the inverter directly on a hard ground may cause damage to its metal enclosure. Protective materials such as sponge pad or foam cushion should be placed underneath the inverter.**
- **Move the inverter by holding the handles on it. Do not move the inverter by holding the terminals.**

## 4.5 Installing Mounting-bracket

The inverter can be installed on a bracket, a wall, and a pole by means of mounting-bracket. Dimensions of the assembled mounting-bracket are as follows.

SG2.0RS-S/SG2.5RS-S/SG3.0RS-S

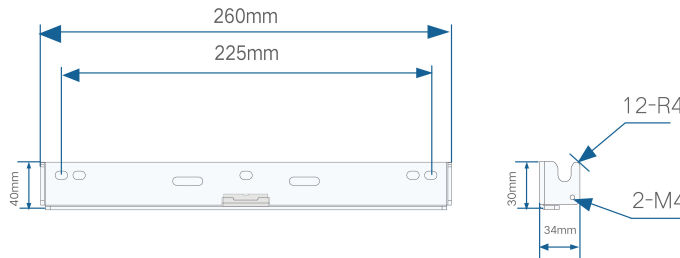

**figure 4-1** Dimensions of Mounting-bracket

SG3.0RS/SG3.6RS/SG4.0RS/SG5.0RS/SG6.0RS

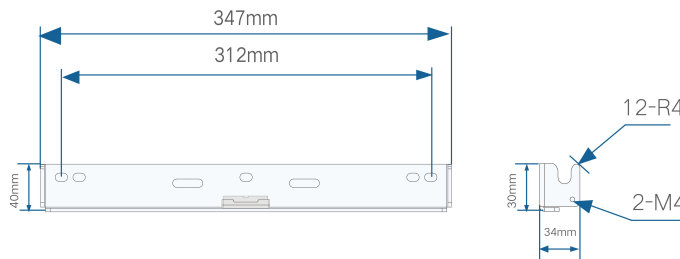

**figure 4-2** Dimensions of Mounting-bracket

Reserve enough space when installing the mounting-bracket to meet the installation space requirements of the inverter.

SG2.0RS-S/SG2.5RS-S/SG3.0RS-S

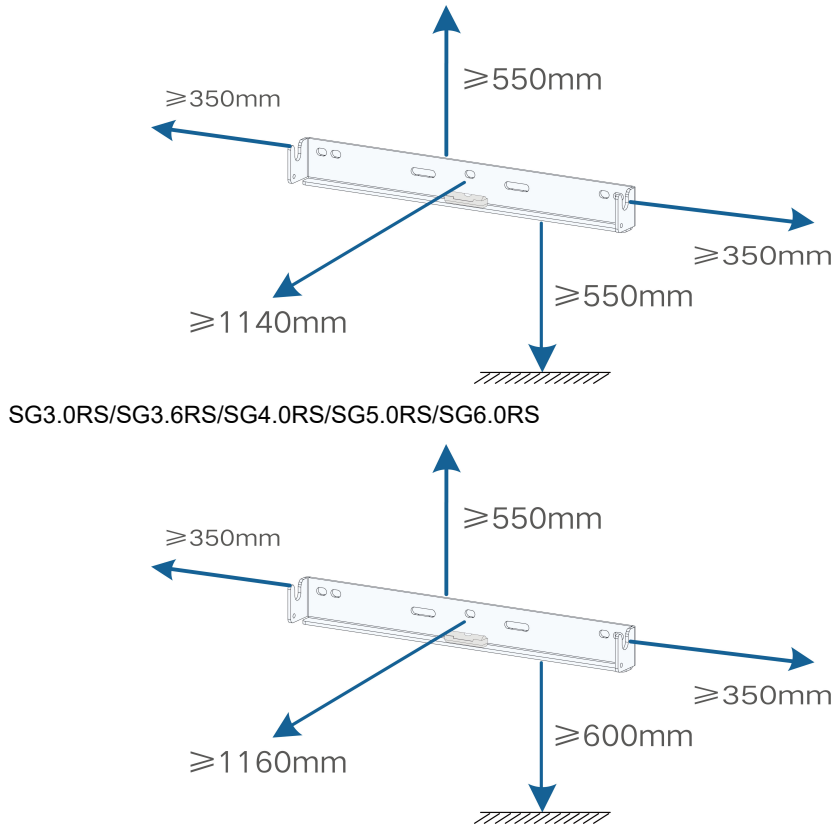

## 4.6 Installing the Inverter

Inverter is installed on the wall by means of wall-mounting bracket and the expansion plug sets.

The expansion plug set shown below is recommended for the installation.

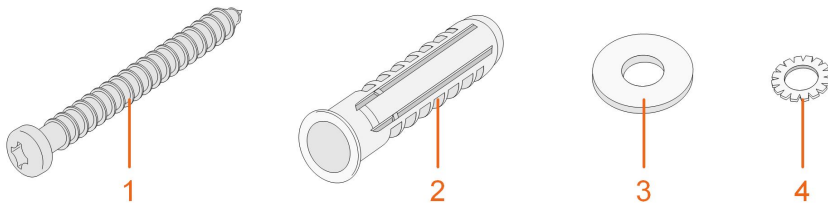

(1) Self-tapping screw M6

(2) Expansion tube

(3) Fender washer

(4) Spring washer

**Step 1** Place the wall-mounting bracket to a proper position on the wall. Mark the positions and drill the holes.

**NOTICE**

**Observe the level on the bracket and adjust until the bubble is in the middle position.**

**The depth of the holes should be about 70 mm.**

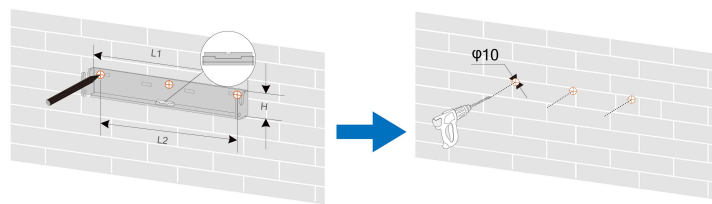

S005-1008

\* The image shown here is for reference only. The actual product received may differ.

Inverter Model	L1 (mm)	L2 (mm)	H (mm)
SG2.0RS-S, SG2.5RS-S, SG3.0RS-S	260	225	40
SG3.0RS, SG3.6RS, SG4.0RS, SG5.0RS, SG6.0RS	347	312	40

**Step 2** Place the expansion tubes into the holes. Then secure the wall-mounting bracket to the wall firmly with the expansion bolt sets.

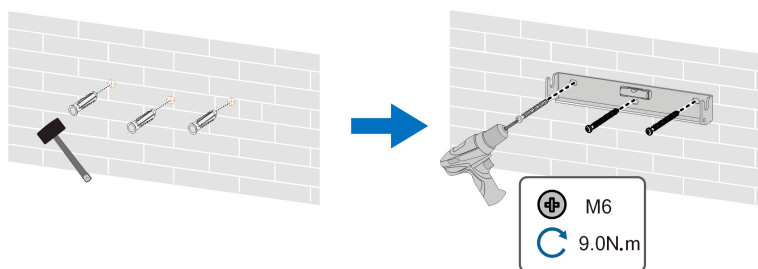

S005-1009

**Step 3** Lift the inverter and slide it down along the wall-mounting bracket to make sure they match perfectly. Use two screw sets to lock both left and right sides.

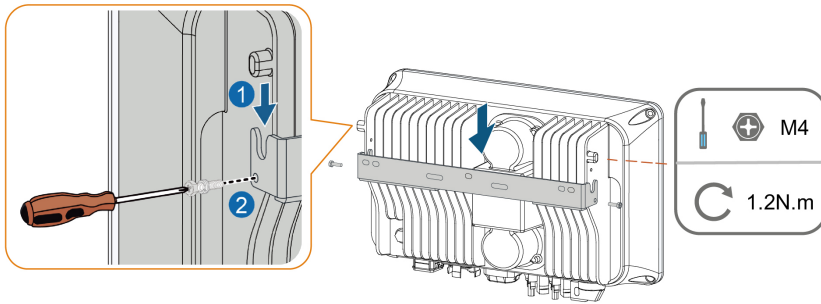

S005-I010

-- End



## 4.7 Installing Optimizer(Optional)

**Step 1** As shown in the figure below, clamp the optimizer parallel to the back of the PV module by clips.

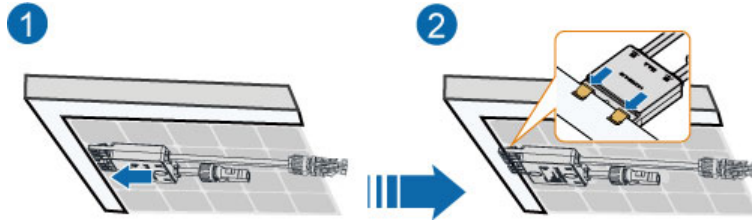

### NOTICE

- Please ensure that the optimizer is installed facing the back of the module. Otherwise, the clip may get damaged.

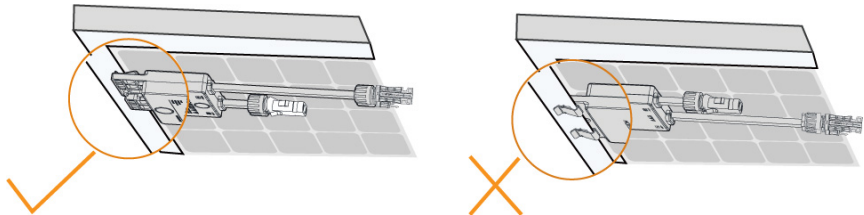

- Do not forcibly bend the clips when installing the optimizer by clips. Otherwise, the clip may be damaged.

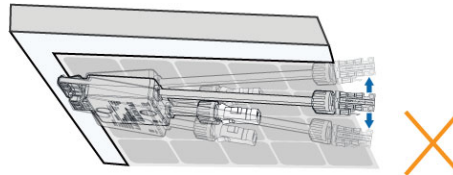

- Do not clamp the optimizer into holes in the module frame during installation. Otherwise, the optimizer cannot be removed or the clips may be damaged.

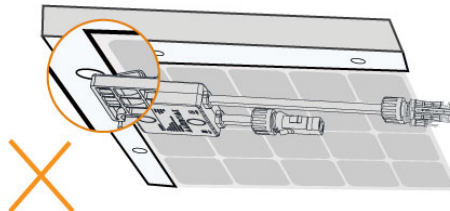

- It is recommended to install optimizers on the same side of modules.
- Do not clamp and remove the optimizer multiple times. Otherwise, the clip may become loose, affecting normal use.

-- End

# 5 Electrical Connection

## 5.1 Safety Instructions

### DANGER

The PV string will generate lethal high voltage when exposed to sunlight.

- Operators must wear proper personal protective equipment during electrical connections.
- Must ensure that cables are voltage-free with a measuring instrument before touching DC cables.
- Respect all safety instructions listed in relevant documents about PV strings.

### DANGER

- Before electrical connections, please make sure that the inverter switch and all switches connected to the inverter are set to "OFF", otherwise electric shock may occur!
- Ensure that the inverter is undamaged and all cables are voltage free before performing electrical work.
- Do not close the AC circuit breaker until the electrical connection is completed.

### WARNING

Do not damage the ground conductor. Do not operate the product in the absence of a properly installed ground conductor. Otherwise, it may cause personal injury or product damage.

Please use measuring devices with an appropriate range. Overvoltage can damage the measuring device and cause personal injury.

Damage to the product caused by incorrect wiring is not covered by the warranty.

- Electrical connection must be performed by professionals.
- Operators must wear proper personal protective equipment during electrical connections.
- All cables used in the PV generation system must be firmly attached, properly insulated, and adequately dimensioned. Cables used shall comply with the requirements of local laws and regulations.
- The factors that affect cable selection include rated current, cable type, routing mode, ambient temperature, and maximum expected line loss.

**NOTICE**

**All electrical connections must comply with local and national/regional electrical standards.**

- **Cables used by the user shall comply with the requirements of local laws and regulations.**
- **Only with the permission of the national/regional grid department, the inverter can be connected to the grid.**

**NOTICE**

- **Install the external protective grounding cable first when performing electrical connection and remove the external protective grounding cable last when removing the inverter.**
- **Keep the AC output cable and the DC input cable close to each other during electrical connection.**
- **Comply with the safety instructions related to PV strings and the regulations related to the utility grid.**

**NOTICE**

- **After being crimped, the OT terminal must wrap the wires completely, and the wires must contact the OT terminal closely.**
- **When using a heat gun, protect the device from being scorched.**
- **Keep the PV+ cable and PV- cable close to each other when connecting DC input cables.**
- **Before connecting a power cable (such as the AC cable, the DC cable, etc.), confirm that the label and identifier on the power cable are correct.**
- **When laying out communication cables, separate them from power cables and keep them away from strong interference sources to prevent communication interruption.**
- **All vacant terminals must be covered with waterproof covers to prevent affecting the protection performance.**
- **Ensure that AC output cables are firmly connected. Failing to do so may cause inverter malfunction or damage to its AC connectors.**
- **When the wiring is completed, seal the gap at the cable inlet and outlet holes with fireproof/waterproof materials such as fireproof mud to prevent foreign matter or moisture from entering and affecting the long-term normal operation of the inverter.**



The cable colors in figures in this manual are for reference only. Please select cables according to local cable standards.

## 5.2 Terminal Description

All electrical terminals are located at the bottom side of the inverter.

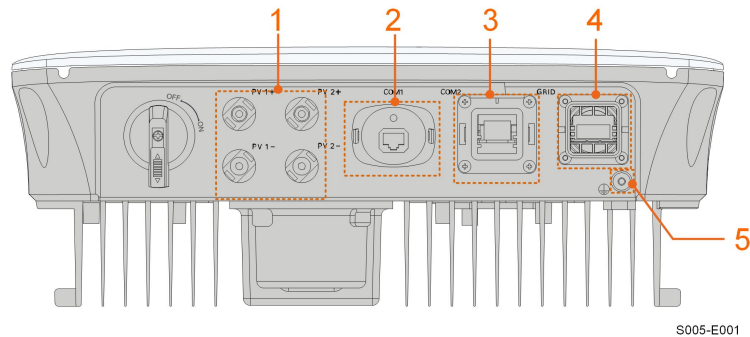

figure 5-1 Terminals (SG3.0RS for example)

\* The image shown here is for reference only. The actual product received may differ.

table 5-1 Terminal Description

No.	Name	Description	Decisive Voltage Classification
1	PV1+, PV1-, PV2+, PV2-	MC4 terminals for PV input. The terminal number depends on inverter model.	DVC-C
2	COM1	Communication accessory port to be connected to WiNet-S communication module.	DVC-A
3	COM2	Communication connection for RS485, DRM and smart energy meter.	DVC-A
4	GRID	AC terminal to connect to the grid.	DVC-C
5		External grounding terminal.	Not applicable

The pin definition of COM2 terminal is shown in the following label.

RS485	Meter	DRM	RSD
A1	A2	R	RSD-1
B1	B2	C	RSD-2

figure 5-2 Label of COM2 Terminal

table 5-2 Label Description of COM2 Terminal

Label	Description	
RS485	A1, B1	Reserved
Meter	A2, B2	For the smart energy meter
DRM	R, C	For external Demand Response Enabling Device ("AU"/"NZ")
RSD	RSD-1, RSD-2	Reserved

### 5.3 Electrical Connection Overview

The electrical connection should be realized as follows:

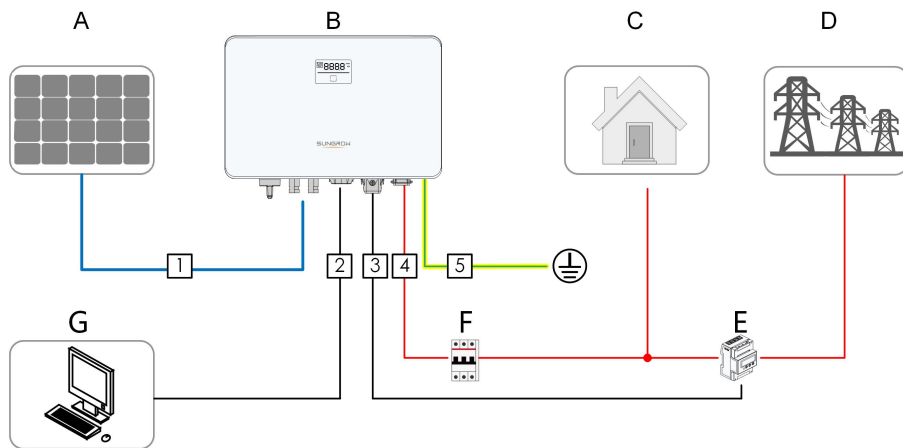

S005-E005

- (A) PV string
- (B) Inverter
- (C) Loads
- (D) Grid
- (E) Smart energy meter (optional)
- (F) AC circuit breaker
- (G) External device

The electrical connection should be realized as follows(Includes optimizer):

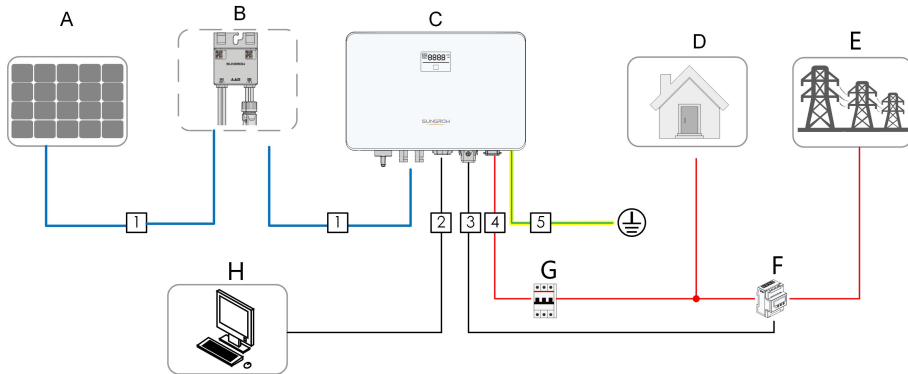

- (A) PV string                      (B) Optimizer                      (C) Inverter
- (D) Loads                              (E) Grid                              (F) Smart energy meter  
(optional)
- (G) AC circuit breaker              (H) External device

table 5-3 Cable Requirements

No.	Cable	Type	Cable Diameter	Wire Conductor Cross-section
1	DC cable	Single or multi-core copper wire complying with 600 V and 20 A standard	6 mm–9 mm	4 mm <sup>2</sup> –6 mm <sup>2</sup>
2	Ethernet cable	CAT 5E outdoor shielded network cable	4.8 mm–6 mm	8 * (0.08–0.2) mm <sup>2</sup>
3	Meter RS485 cable (1)	Shielded twisted pair	4.8 mm–6 mm	2 * (0.5–1.0) mm <sup>2</sup>
4	AC cable (2)	Outdoor 3-core copper wire cable	10 mm–21 mm	4 mm <sup>2</sup> –6 mm <sup>2</sup>
5	External Grounding cable	Outdoor single-core copper wire cable	4 mm –8 mm	4 mm <sup>2</sup> –6 mm <sup>2</sup>

(1) The cable requirements for **COM2** terminal connection are the same.

(2) All the AC wires should be equipped with correctly colored cables for distinguishing. Please refer to related standards about the wiring color.

(3) The factors that affect cable selection include rated current, cable type, routing mode, ambient temperature, and maximum expected line loss.



It is recommended to use heavy duty conduits when run cables through Cavity walls, or lay out cables with corresponding conduits. (For “AU” and “NZ”)

## 5.4 External Protective Grounding Connection

### DANGER

- There are large currents during the inverter's operation. If the inverter is powered on and put into operation without being grounded, it may lead to electric shock hazards or failures of major protective functions such as surge protection. Therefore, before powering on the inverter, make sure it has been reliably grounded; otherwise, damages caused therefrom will not be covered by warranty.
- When performing electrical connections of the inverter, give the highest priority to grounding. Be sure to carry out the grounding connection first.

### WARNING

- Since the inverter is not equipped with a transformer, neither the negative electrode nor the positive electrode of the PV string can be grounded. Otherwise, the inverter will not operate normally.
- Connect the grounding terminal to the external protective grounding point before AC cable connection, PV string connection, and communication cable connection.
- The external protective grounding point provides a reliable ground connection. Do not use an improper grounding conductor for grounding. Otherwise, it may cause product damage or personal injury.
- Depending on Local Rules, please also ground the PV panel subconstruction to the same common grounding point (PE Bar) in addition to local lightning protection rules.

### WARNING

The external protective grounding terminal must meet at least one of the following requirements.

- The cross-sectional area of the grounding cable is not less than 10 mm<sup>2</sup> for copper wire or 16 mm<sup>2</sup> for aluminum wire. It is recommended that both the external protective grounding terminal and the AC side grounding terminal be reliably grounded.
- If the cross-sectional area of the grounding cable is less than 10 mm<sup>2</sup> for copper wire or 16 mm<sup>2</sup> for aluminum wire, ensure that both the external protective grounding terminal and the AC side grounding terminal are reliably grounded.

The grounding connection can be made by other means if they are in accordance with the local standards and regulations, and SUNGROW shall not be held liable for the possible consequences.

### 5.4.1 External Protective Grounding Requirements

All non-current carrying metal parts and device enclosures in the PV power system should be grounded, for example, brackets of PV modules and inverter enclosure.

When there is only one inverter in the PV system, connect the external protective grounding cable to a nearby grounding point.

When there are multiple inverters in the PV system, connect the external protective grounding terminals of all inverters and the grounding points of the PV module brackets to ensure equipotential connections to ground cables (according to the onsite conditions).

### 5.4.2 Connection Procedure

External grounding cable and OT/DT terminal are prepared by customers.

**Step 1** Prepare the cable and OT/DT terminal.

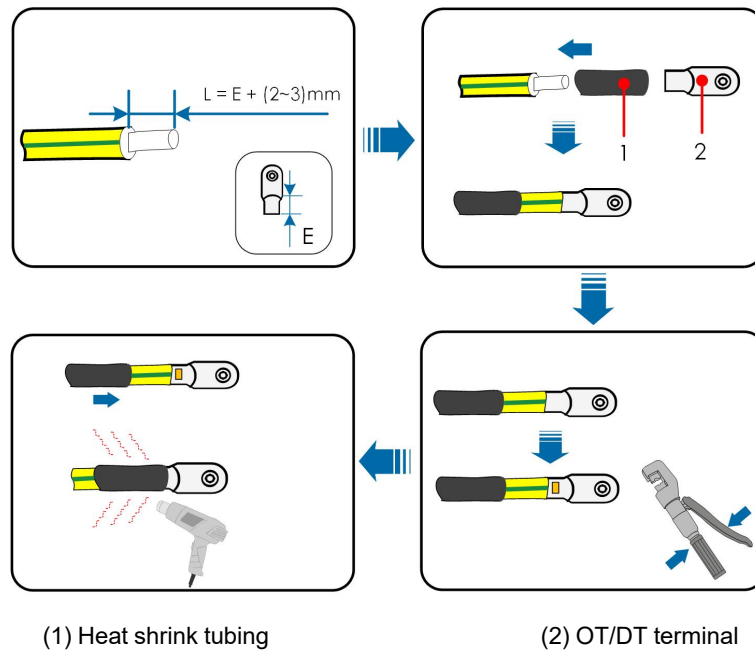

After being crimped, the OT terminal must wrap the wires completely, and the wires must contact the OT terminal closely.

When using a heat gun, protect the device from being scorched.



**Step 2** Remove the screw on the grounding terminal and fasten the cable with a screwdriver.

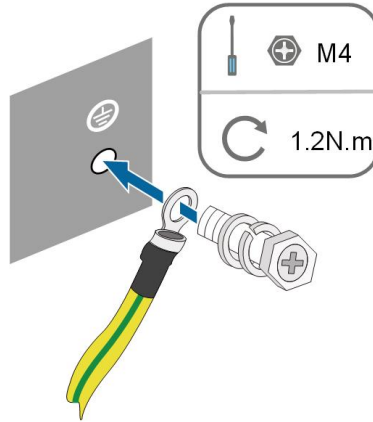

S000-E063

**Step 3** Apply paint to the grounding terminal to ensure corrosion resistance.

-- End

## 5.5 AC Cable Connection

### 5.5.1 AC Side Requirements



Only with the permission of the local grid department, the inverter can be connected to the grid.

Before connecting the inverter to the grid, ensure the grid voltage and frequency comply with requirements, for which, refer to "**Technical Data**". Otherwise, contact the electric power company for help.

#### AC Circuit Breaker

An independent two-pole circuit breaker must be installed on the output side of the inverter to ensure safe disconnection from the grid. The recommended specifications are as follows.

Inverter Model	Recommended Specification
SG2.0RS-S/SG2.5RS-S/SG3.0RS-S	25 A
SG3.0RS/SG3.6RS/SG4.0RS/SG5.0RS	32 A
SG6.0RS	40 A

#### NOTICE

Testing to AS/NNZS 4777.2:2020 Section for multiple phase combinations has not been conducted.

**⚠ WARNING**

**AC circuit breakers should be installed on the output side of the inverter and the grid side to ensure safe disconnection from the grid.**

- **Determine whether an AC circuit breaker with greater overcurrent capacity is required based on actual conditions.**
- **Do not connect any local load between the inverter and the AC circuit breaker.**
- **Multiple inverters cannot share one AC circuit breaker.**

**Residual Current Monitoring Device**

With an integrated universal current-sensitive residual current monitoring unit included, the inverter will disconnect immediately from the mains power once a fault current with a value exceeding the limit is detected.

However if an external residual current device (RCD) (type A is recommended) is mandatory, the switch must be triggered at a residual current of 300 mA (recommended). RCD of other specifications can also be used according to local standard.

In Australia, a RCD is not required according to the local standard AS3000-2018 when either of the following installation methods is adopted if the PV array capacitance to ground is large (such as a tin roof):

- Use heavy duty conduits (such as metal bushing) when run PV and AC cables through Cavity walls.
- Route the PV and AC cables through pipes (PVC or metal tubing), lay the cables and install them.

**5.5.2 Assembling the AC Connector**

**Step 1** Unscrew the swivel nut of the AC connector.

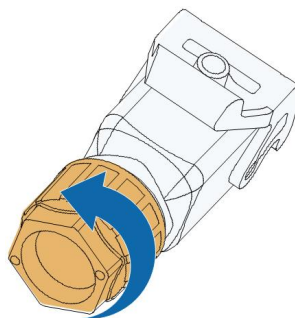

S000-E047

**Step 2** Thread the AC cable of appropriate length through the swivel nut, the sealing ring and the housing.

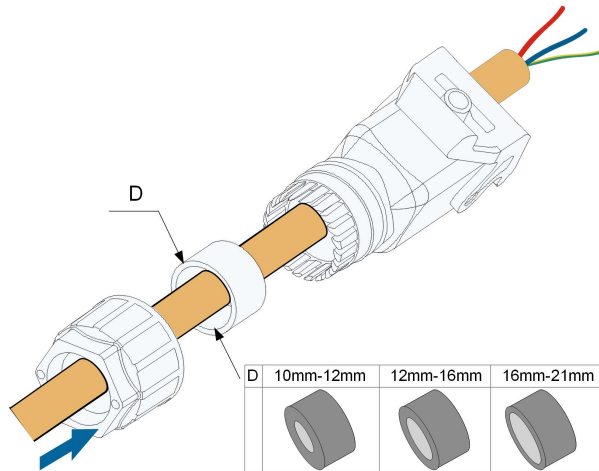

S000-E049

**Step 3** Remove the cable jacket by less than 45 mm, and strip the wire insulation by 12 mm–16 mm.

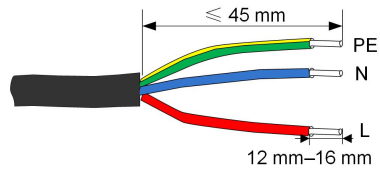

S000-E050

**Step 4** Open the clamp on the spring-loaded terminal and fully insert the wires into the corresponding holes. Then close the clamp and push the terminal plug into the housing until there is an audible click.

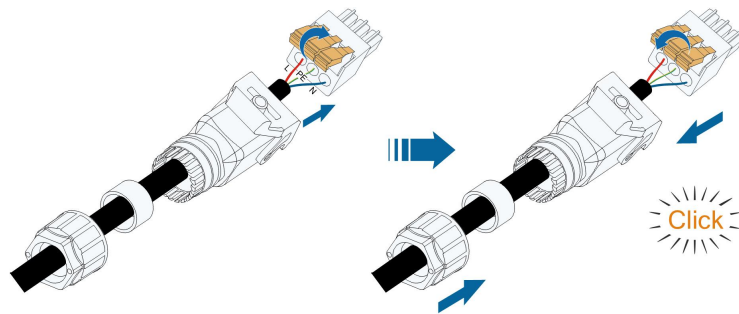

S000-E051

#### NOTICE

**Observe the plug assignment.**

- Do not connect the L line to the "PE" terminal or the PE wire to the "N" terminal. Otherwise, unrecoverable damage to the inverter may follow.
- Do not connect the L line and the N line in reverse, otherwise the inverter may not operate normally.

**Step 5** Ensure that the wires are securely in place by slightly pulling them. Tighten the swivel nut to the housing.

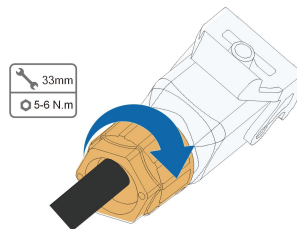

S000-E052

-- End

### 5.5.3 Installing the AC Connector

#### **⚠ DANGER**

**High voltage may be present in inverter!**

**Ensure all cables are voltage-free before electrical connection.**

**Do not connect the AC circuit breaker until all inverter electrical connections are completed.**

**Step 1** Disconnect the AC circuit breaker and secure it against reconnection.

**Step 2** Lift the locking part upwards and insert the AC connector into the **GRID** terminal on the bottom side of the inverter. Then press the locking part and lock it with the screw.

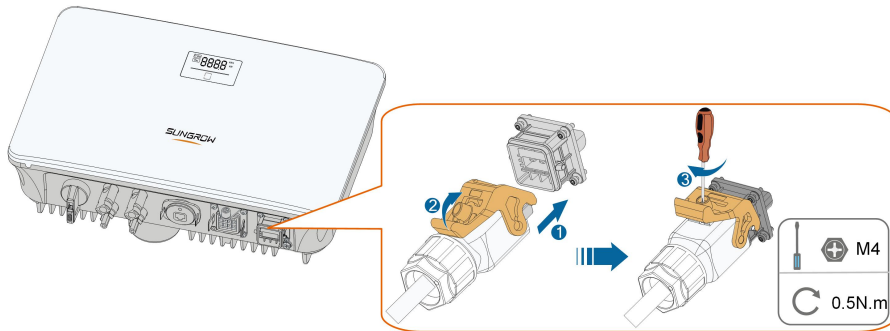

S005-E006

**Step 3** Connect the PE wire to ground and the phase lines and the “N” line to AC circuit breaker. Then Connect the AC circuit breaker to electric board.

**Step 4** Make sure all wires are firmly installed via the right torque tool or dragging the cables slightly.

-- End

## 5.6 DC Cable Connection

### **⚠ DANGER**

**The PV string will generate lethal high voltage when exposed to sunlight.**

- **Respect all safety instructions listed in relevant documents about PV strings.**

**⚠ WARNING**

- **Make sure the PV array is well insulated to ground before connecting it to the inverter.**
- **Make sure the maximum DC voltage and the maximum short circuit current of any string never exceed inverter permitted values specified in "Technical Data".**
- **Check the positive and negative polarity of the PV strings, and connect the PV connectors to corresponding terminals only after ensuring polarity correctness.**
- **During the installation and operation of the inverter, please ensure that the positive or negative electrodes of PV strings do not short-circuit to the ground. Otherwise, an AC or DC short-circuit may occur, resulting in equipment damage. The damage caused by this is not covered by the warranty.**
- **Electric arc or contactor over-temperature may occur if the DC connectors are not firmly in place, and the loss caused is not covered by the warranty.**
- **If the DC input cables are reversely connected or the positive and negative terminals of different MPPT are shorted to ground at the same time, while the DC switch is in the "ON" position, do not operate immediately. Otherwise, the inverter may be damaged. Please turn the DC switch to "OFF" and remove the DC connector to adjust the polarity of the strings when the string current is lower than 0.5 A.**
- **Use the DC connectors supplied with the product for DC cable connection. Using incompatible DC connectors may result in serious consequences, and the device damage is not covered under warranty.**
- **Inverters do not support full parallel connection of strings (Full parallel connection refers to a connection method in that strings are connected in parallel and then connected to the inverter separately).**
- **Do not connect one PV string to multiple inverters. Otherwise, the inverters may be damaged.**

**NOTICE**

The following requirements about PV string connection must be met. Otherwise, it may cause irreversible damage to the inverter, which is not covered by the warranty.

- **Mixed use of PV modules of different brands or models in one MPPT circuit, or PV modules of different orientation or inclination in a string may not damage inverter, but will cause system bad performance!**
- **The inverter enters standby state when the input voltage ranges between 560 V and 600 V. The inverter returns to running state once the voltage returns to the MPPT operating voltage range, namely, 40 V to 560 V.**

**NOTICE**

**Note the following items when laying out cables on site:**

- **The axial tension on PV connectors must not exceed 80 N. Avoid axial cable stress on the connector for a long time during field wiring.**
- **Radial stress or torque must not be generated on PV connectors. It may cause the connector waterproof failure and reduce connector reliability.**
- **Leave at least 50 mm of slack to avoid the external force generated by the cable bending affecting the waterproof performance.**
- **Refer to the specifications provided by the cable manufacturer for the minimum cable bending radius. If the required bending radius is less than 50 mm, reserve a bending radius of 50 mm. If the required bending radius is greater than 50 mm, reserve the required minimum bending radius during wiring.**

**5.6.1 PV Input Configuration**

- The inverters SG3.0RS / SG4.0RS / SG5.0RS / SG6.0RS have two PV inputs, each with independent MPP tracker. Each DC input area can operate independently.
- The PV strings to the same DC input area should have the same type, the same number of PV panels, identical tilt and identical orientation for maximum power.
- The PV strings to two DC input areas may differ from each other, including PV module type, number of PV modules in each string, angle of tilt, and installation orientation.

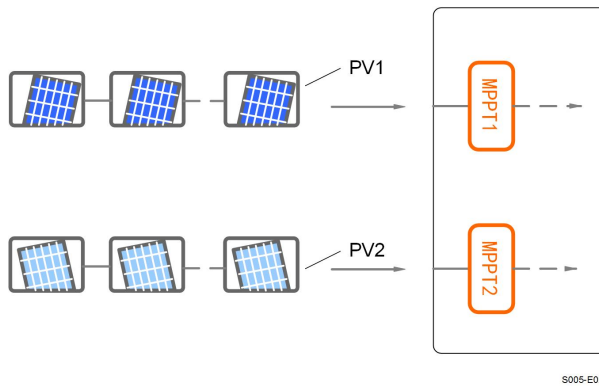

**figure 5-3** PV Input Configuration (SG6.0RS for example)

Prior to connecting the inverter to PV inputs, the specifications in the following table should be met:

Inverter Model	Open-circuit Voltage Limit	Max. current for input connector
All models	600 V	20 A

## 5.6.2 Assembling the PV Connectors

### **⚠ DANGER**

**High voltage may be present in the inverter!**

- **Ensure all cables are voltage-free before performing electrical operations.**
- **Do not connect the DC switch and AC circuit breaker before finishing electrical connection.**



To ensure IP65 protection, use only the supplied connector.

**Step 1** Strip the insulation from each DC cable by 7 mm–8 mm.

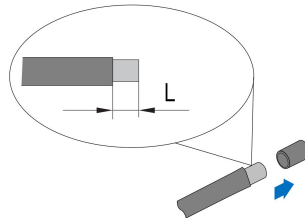

**Step 2** Assemble the cable ends with the crimping pliers.

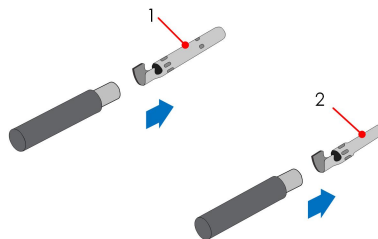

1: Positive crimp contact

2: Negative crimp contact

**Step 3** Lead the cable through cable gland, and insert the crimp contact into the insulator until it snaps into place. Gently pull the cable backward to ensure firm connection. Tighten the cable gland and the insulator (torque 2.5 N.m to 3 N.m).

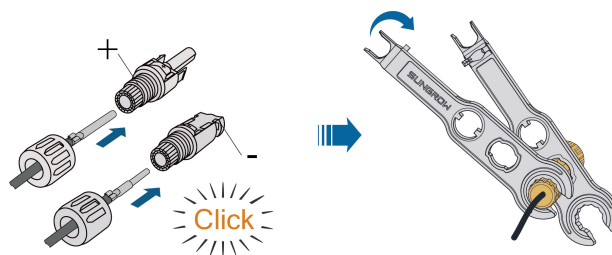



**Step 4** Check for polarity correctness.

**NOTICE**

**If the PV polarity is reversed, the inverter will be in a fault or alarm state and will not operate normally.**

-- End

### 5.6.3 Installing the PV Connectors

**Step 1** Rotate the DC switch to "OFF" position.

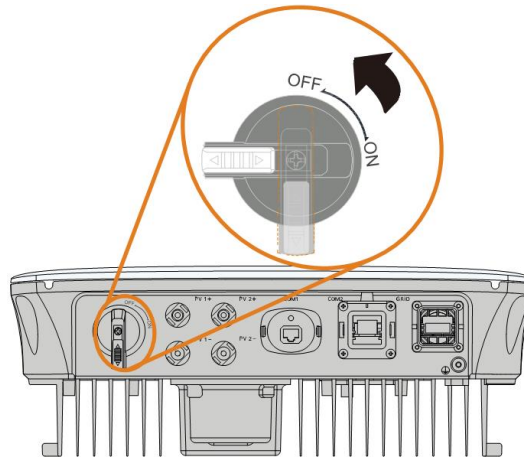

S005-E032

**Step 2** Check the cable connection of the PV string for polarity correctness and ensure that the open circuit voltage in any case does not exceed the inverter input limit of 600 V.

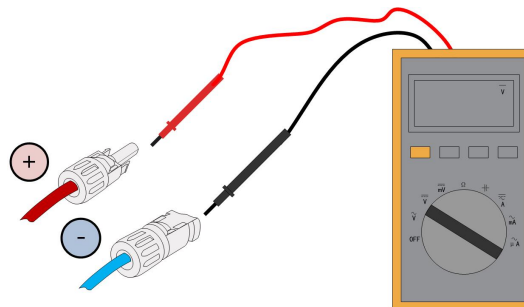

**Step 3** Connect the PV connectors to corresponding terminals until there is an audible click.

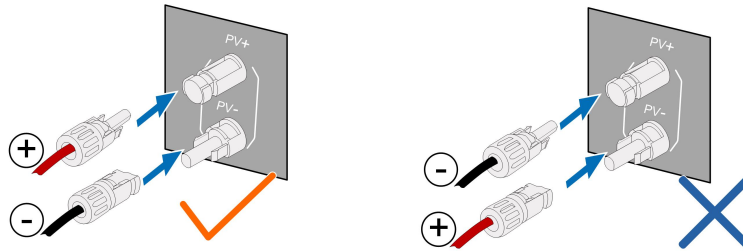

**Step 4** Seal the unused PV terminals with the terminal caps.

**Step 5** Connect the PV+ and PV- of the optimizer to the positive and negative terminals in the junction box of the PV module respectively.

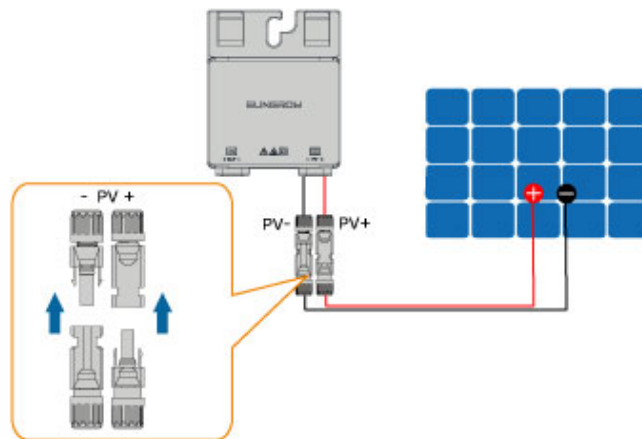

#### NOTICE

**Do not connect the PV module to the OUT+ and OUT- of the optimizer. Otherwise, the optimizer or PV module will be damaged, and the loss is not covered by the warranty.**

**Step 6** Connect the positive probe of a multimeter to OUT+ of the optimizer, and the negative probe of the multimeter to OUT— of the optimizer to check whether the optimizer is faulty. If typical value of output voltage is 1V, no fault occurs to the optimizer.

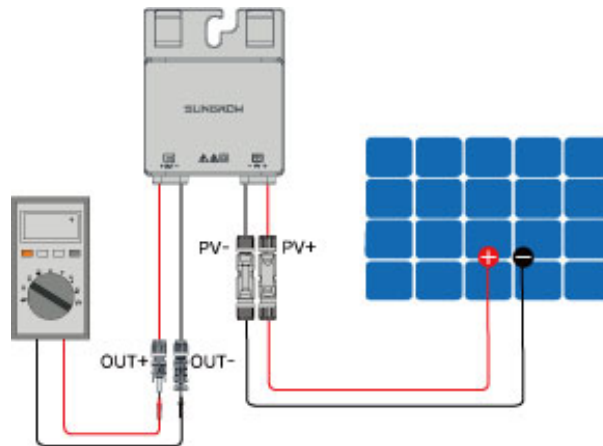

#### NOTICE

1. Use a multimeter to measure the output voltage of each optimizer after wiring.
2. Considering the effect of the accuracy of the multimeter on the actual measurement on site, the optimizer can function normally as long as the output voltage falls in the range of 0.9V - 1.1V.
3. If the output voltage is less than 0.9 V, check the following items:
  - Check whether the sunlight is sufficient.
  - Check whether the input side of the optimizer is connected to the PV module.
  - If the fault is not caused by foregoing reasons and still persists, please replace the optimizer.
4. If the output voltage is greater than 1.1 V, the optimizer fails. Please replace the optimizer.
5. If no voltage is detected, replace the optimizer or component.

**Step 7** When connecting multiple optimizers, connect OUT- of the first optimizer to OUT + of the second optimizer, and so on. Use a multimeter to measure the optimizer voltage. If typical value of output voltage is  $1V*N$  (N is the number of optimizers), no fault occurs to the system.

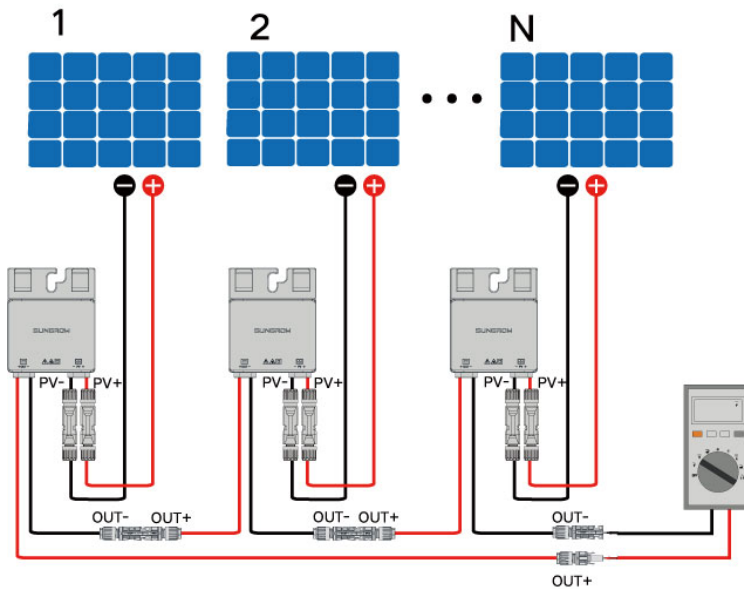

#### NOTICE

Whether connecting OUT+ of the first optimizer to OUT- of the second optimizer or connecting OUT- of the first optimizer to OUT+ of the second optimizer is dependent on the polarity of the extension cable that is connected to the inverter on site.

**Step 8** Connect OUT+ of the first optimizer and OUT- of the last optimizer to the PV input terminals of the inverter.

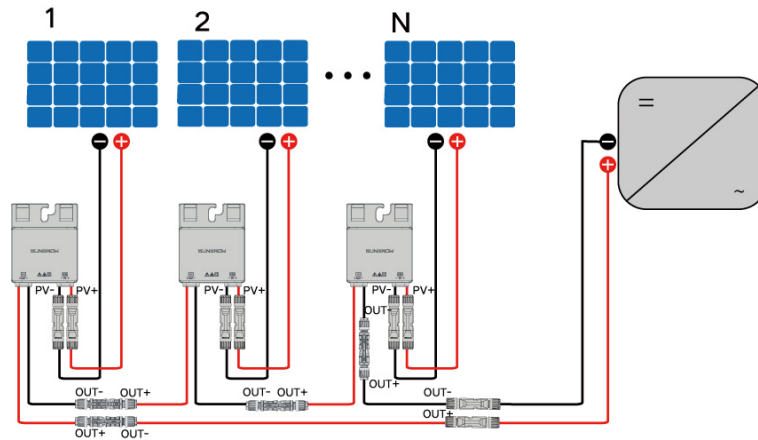

#### ⚠ WARNING

If each PV module is equipped with an optimizer, the total power of PV modules in a PV input shall not exceed the maximum input power of a single PV input of the inverter.

#### NOTICE

- Branch-connector connection on the input side of the inverter is not supported by the optimizer.
- Please refer to the optimizer user manual for details.



-- End

## 5.7 WiNet-S Connection

The WiNet-S module supports Ethernet communication and WLAN communication. It is not recommended to use both communication methods at the same time.

For details, see the quick guide for the WiNet-S module. Scan the following QR code for the quick guide.



### 5.7.1 Ethernet Communication

**Step 1 (Optional)** Strip the insulation layer of the communication cable with an Ethernet wire stripper, and lead the corresponding signal cables out. Insert the stripped communication cable into the RJ45 plug in the correct order, and crimp it with a crimper.

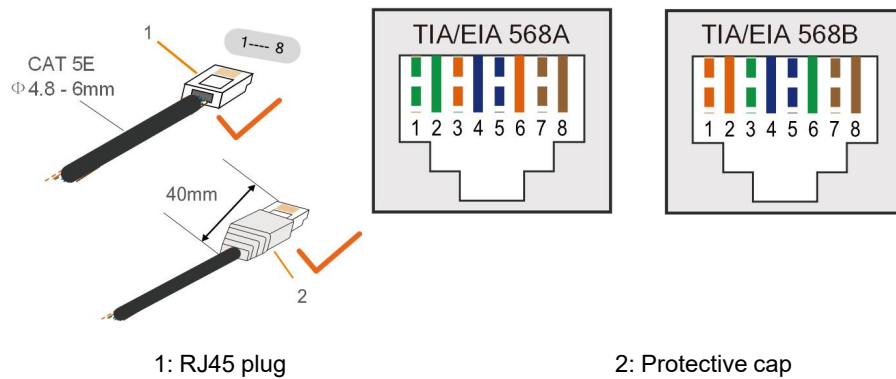

Skip this step if a standard network cable with RJ45 plug is prepared.

**Step 2** Unscrew the swivel nut from the communication module and take out the inner sealing ring.

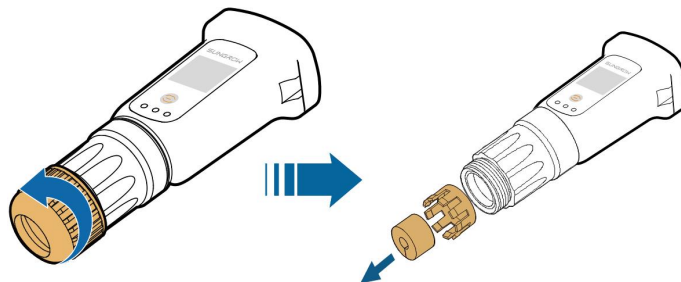

**Step 3** Unscrew the housing from the communication module.

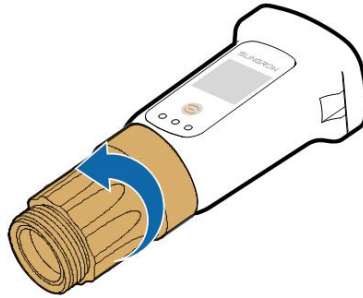

**Step 4** Thread the network cable through the swivel nut and gasket. Afterwards, route the cable into the opening of the sealing. Finally, insert the cable through the housing.

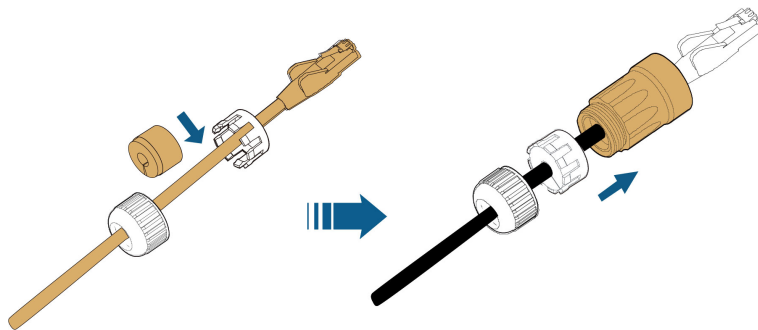

**Step 5** Insert the RJ45 plug into the front plug connector until there is an audible click and tighten the housing. Install the gasket and fasten the swivel nut.

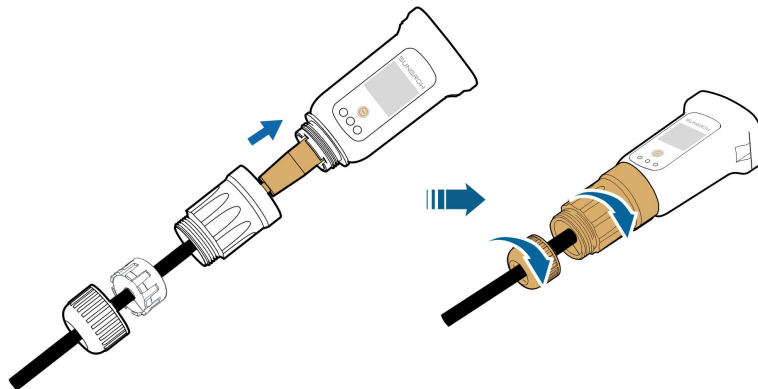

**Step 6** Remove the waterproof lid from the **COM1** terminal and install WiNet-S.

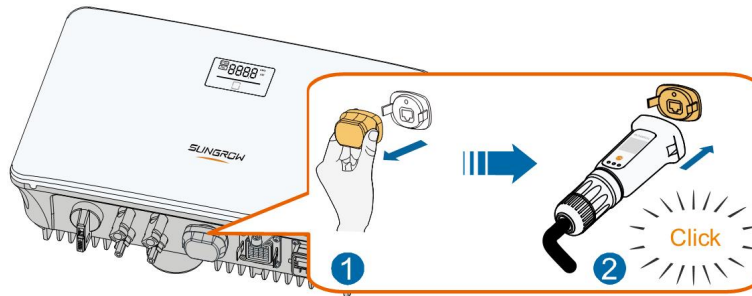

S005-E041

**Step 7** Slightly shake it by hand to determine whether it is installed firmly.

-- End

### 5.7.2 WLAN Communication

**Step 1** Remove the waterproof lid from the **COM1** terminal.

**Step 2** Install the module. Slightly shake it by hand to determine whether it is installed firmly, as shown below.

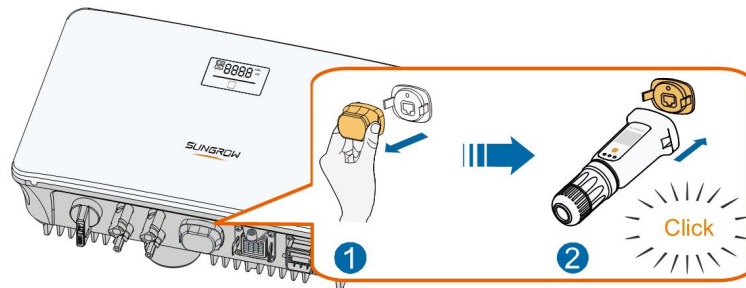

S005-E042

**Step 3** Refer to the guide delivered with the module for the set-up.

-- End

## 5.8 Smart Meter Connection

The inverter can provide export control but will require the use of an external smart meter. The export control functionality has not been tested to AS/NZS 4777.2:2020.

The energy meter is mainly used to detect the direction and magnitude of the current. And the energy meter data may not be used for billing purposes.



**Step 1** Unscrew the swivel nut from the communication connector.

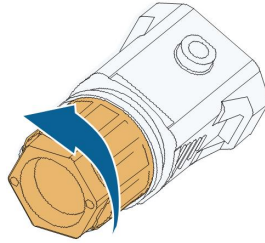

S005-E007

**Step 2** Remove the seal and lead the cable through the cable gland.

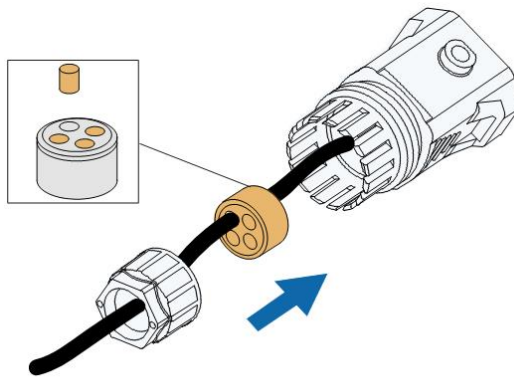

S005-E008

**Step 3** Remove the cable jacket and strip the wire insulation.

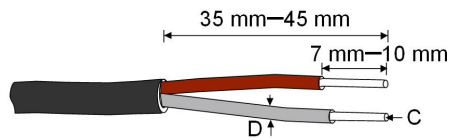

$C = 0.5 \text{ mm}^2 : D \leq 2.6 \text{ mm}$

$C = 1.0 \text{ mm}^2 : D \leq 2.8 \text{ mm}$

S005-E044

**Step 4** (Optional) When using a multi-core multi-strand wire cable, connect the wire head to the cord end terminal. In case of single-strand copper wire, skip this step.

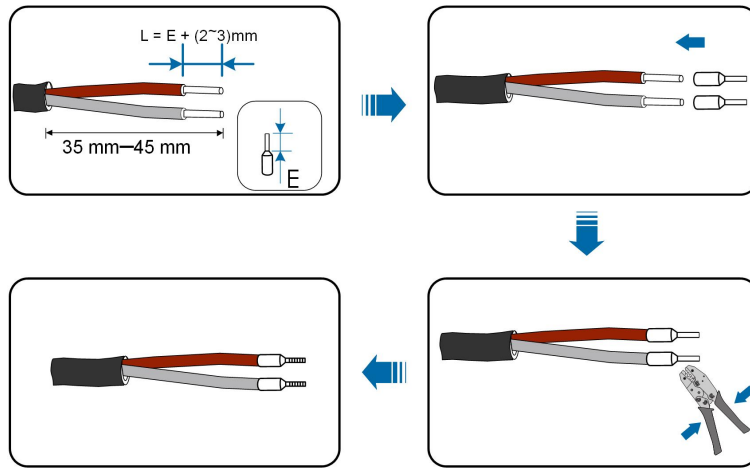

S005-E045

**Step 5** Plug the wires into the corresponding terminals as shown in the following figure. Ensure that the wires are securely in place by slightly pulling them.

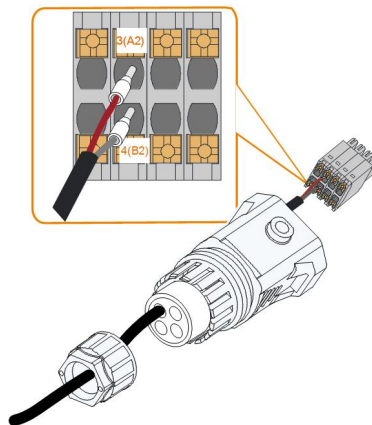

S005-E009

**Step 6** Insert the terminal plug into the **COM2** terminal at the bottom side of the inverter and then install the housing.

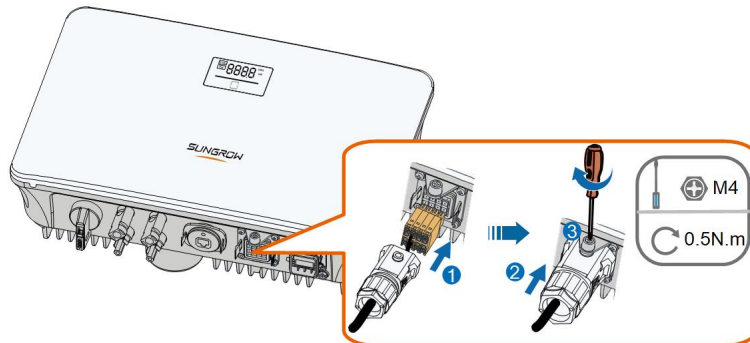

S005-E010

**Step 7** Slightly pull out the cable and then fasten the swivel nut. Lock the connector with the screw.

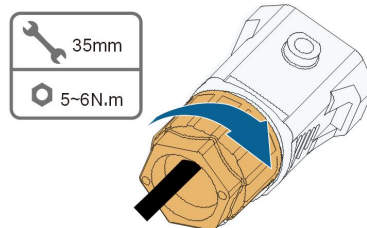

S005-E011

**Step 8** The other end of the communication cable is connected to the RS485A and RS485B ports of the smart meter.

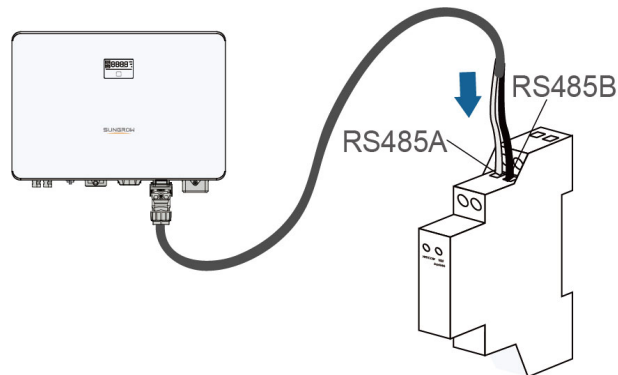

-- End

## 5.9 DRM Connection

In Australia and New Zealand, the inverter supports DRM0 as specified in the standard AS/NZS 4777.

The DRM0 mode is asserted by shorting terminals **R** and **C** on the inverter.

**Step 1** Unscrew the swivel nut from the communication connector.

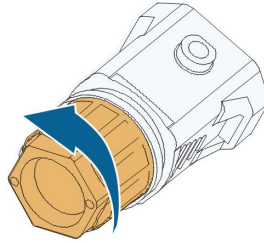

S005-E007

**Step 2** Remove the seal and lead the cable through the cable gland.

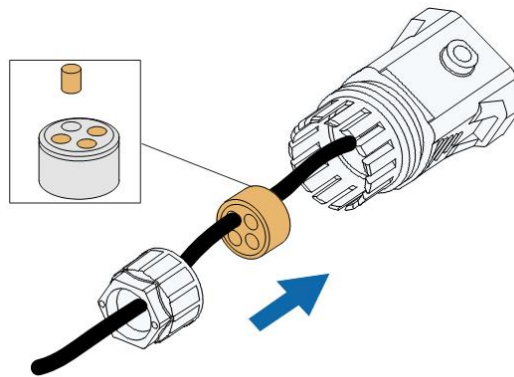

S005-E008

**Step 3** Remove the cable jacket and strip the wire insulation.

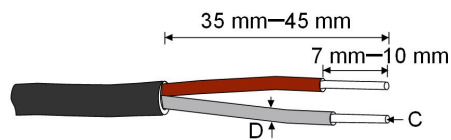

$$C = 0.5 \text{ mm}^2: D \leq 2.6 \text{ mm}$$

$$C = 1.0 \text{ mm}^2: D \leq 2.8 \text{ mm}$$

S005-E044

**Step 4** (Optional) When using a multi-core multi-strand wire cable, connect the wire head to the cord end terminal. In case of single-strand copper wire, skip this step.

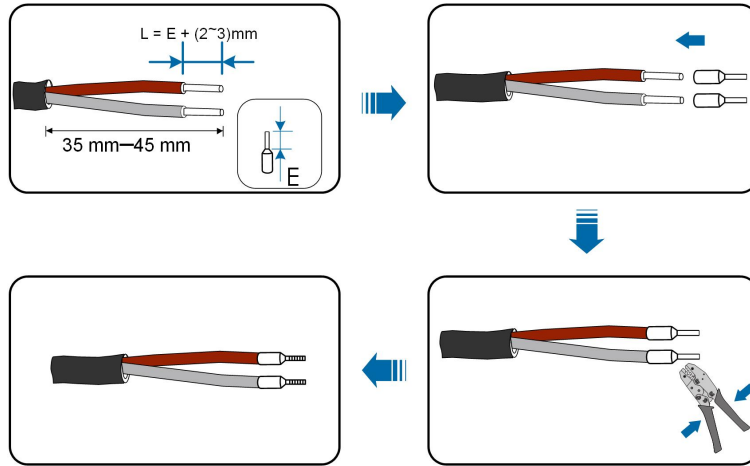

S005-E045

**Step 5** Plug the wires into the corresponding terminals as shown in the following figure. Ensure that the wires are securely in place by slightly pulling them.

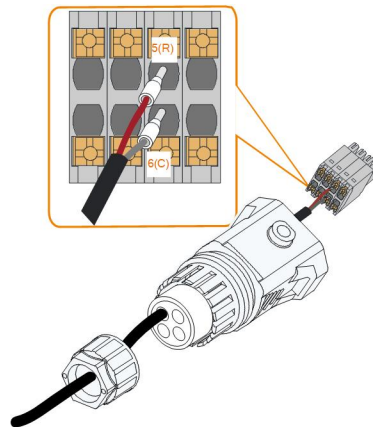

S005-E012

**Step 6** Insert the terminal plug into the **COM2** terminal at the bottom side of the inverter and then install the housing.

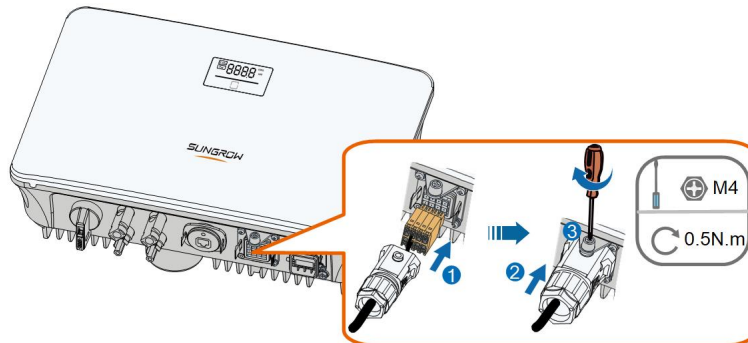

S005-E010

**Step 7** Slightly pull out the cable and then fasten the swivel nut. Lock the connector with the screw.

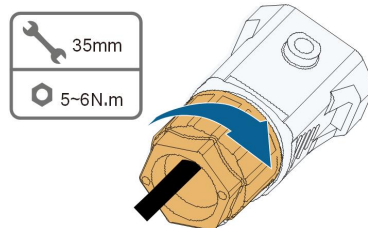

S005-E011

-- End

# 6 Commissioning

## 6.1 Inspection Before Commissioning

Check the following items before starting the inverter:

- All equipment has been reliably installed.
- DC switch(es) and AC circuit breaker are in the "OFF" position.
- The ground cable is properly and reliably connected.
- The AC cable is properly and reliably connected.
- The DC cable is properly and reliably connected.
- The communication cable is properly and reliably connected.
- The vacant terminals are sealed.
- No foreign items, such as tools, are left on the top of the machine or in the junction box (if there is).
- The AC circuit breaker is selected in accordance with the requirements of this manual and local standards.
- All warning signs & labels are intact and legible.

## 6.2 Powering on the System

If all of the items mentioned above meet the requirements, proceed as follows to start up the inverter for the first time.

Strictly follow the preceding sequence. Otherwise, the product may be damaged, and the loss caused is not covered by the warranty.

**Step 1** Turn on the AC circuit breaker between the inverter and the grid.



Before closing the AC circuit breaker between the inverter and the power grid, use a multimeter that is set to the AC gear to ensure that the AC voltage is within the specified range. Otherwise, the inverter may be damaged.

**Step 2** Rotate the DC switch of the inverter to "ON" position.

**Step 3** Turn on the external DC switch (if applicable) between the inverter and the PV string.

**Step 4** If the irradiation and grid conditions meet requirements, the inverter will operate normally. Observe the LED indicator to ensure that the inverter operates normally. Refer to ["2.4 LED Panel"](#) for LED screen introduction and LED indicator definition.

**Step 5** Refer to the quick guide for WiNet-S. for its indicator definition.

-- End

## 6.3 App Preparation

**Step 1** Install the iSolarCloud App with latest version. Refer to "7.2 Installing App".

**Step 2** Register an account. Refer to "7.3 Account Registration". If you have got the account and password from the distributor/installer or SUNGROW, skip this step.

**Step 3** Download the firmware package to the mobile device in advance. Refer to "Firmware Update". This is to avoid download failure due to poor on-site network signal.

-- End

## 6.4 Creating a Plant

Prerequisites:

- The account and password for logging in to iSolarCloud App have been obtained from the distributor/installer or SUNGROW.
- The communication device is normally connected to the inverter.
- System positioning is enabled and iSolarCloud App is allowed to access location information.



**Step 1** Open the App, tap **More** in the upper right corner of the interface, and select the correct access address.

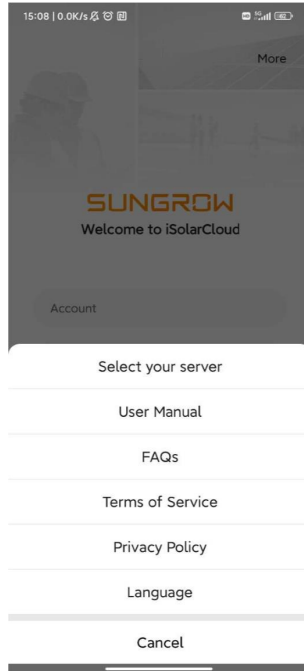

**figure 6-1** Select Access Address

**Step 2** Enter the account and password on the login interface, and tap **LOGIN** to log in.

**Step 3** Tap **+** in the upper right corner to enter the plant creation interface.

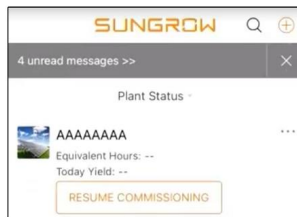

**Step 4** Fill in the content according to actual needs, and the parameters containing \* are required. Tap **Next** to enter the next interface.

The figure shows two sequential screens of the 'CREATE PLANT' process. The first screen (left) is the main form with the following fields:
 

- \* Plant Name: Please Enter
- \* Plant Type: Please Select (with an information icon)
- \* Installed PV Power (kWp): Please Enter
- \* Country/Region: China
- \* Time Zone: GMT+8 (Beijing, Chongqing, Hong Kong, Urumqi)
- \* Plant Address: 安徽省合肥市蜀山区高新技术产业开发区 习友路阳光电源股份有限公司
- \* Grid-connection Type: Please Select

 An orange 'NEXT' button is at the bottom. The second screen (right) shows configuration options:
 

- \* Grid-connection Type: Please Select
- Grid-connected Date: 2022-05-26
- \* Owner's Email Address: Please Enter (with a note: 'Enter new owner email address or existed owner email address in iSolarCloud system.')
- Postal Code: Please Enter
- Plant Image: A plus sign icon for adding an image.
- Feed-in Tariff(CNY/kWh): Please Enter
- More Configurations: A blue link.
- How to duplicate the plant information with one click: A link with a right arrow.

 An orange 'NEXT' button is at the bottom.

figure 6-2 Plant Creation Settings

Parameter Name	Description
Plant name	The name of the plant.
Plant type	The type of the plant, which should be set corresponding to the actual plant type.
Installed power	The installed power of the plant.
Country/Region	The country/region where the plant is located.
Time zone	The time zone where the plant is located, which can be filled through automatic positioning and manual input.

Parameter Name	Description
Plant address	<p>The location of the plant, which can be filled in two ways:</p> <ul style="list-style-type: none"> <li>• <b>Manually:</b> Manually enter the plant location in the input box.</li> <li>• <b>Automatically:</b> Tap  to automatically obtain the current location or search for the location of the plant, and then tap <b>Confirm</b>.</li> </ul>
Grid-connection type	The way the plant is connected to the grid, including <b>100% Feed-in, Self-Consumption, Zero Export, and Off-grid</b> .
Grid-connected date	The time when the plant is connected to the grid.
Owner's email address	Fill in the owner information of the plant, and both registered and un-registered email addresses are supported.
Postal code	The postal code of the place where the plant is located.
Plant image	Take photos of the plant and upload them.
Feed-in tariff	<p>The feed-in tariff can be set in two ways:</p> <ul style="list-style-type: none"> <li>• Enter the feed-in tariff directly in the input box.</li> <li>• Tap <b>More Configurations</b>, select the tariff unit, enter the feed-in tariff, and tap <b>Confirm</b>. Enable <b>Time-of-Use Tariff</b> if needed. Tap <b>Add Time-of-Use Tariff</b>, add time intervals and price, and tap <b>Confirm</b>. Please note that if <b>Time-of-use Tariff</b> is enabled, the time periods shall cover 24 hours a day, and can not overlap.</li> </ul>
Consumption tariff	<p>Set the consumption tariff as follows:</p> <ul style="list-style-type: none"> <li>• Tap <b>More Configurations</b>, select the tariff unit, enter the consumption tariff, and tap <b>Confirm</b>. Enable <b>Time-of-Use Tariff</b> if needed, and refer to the setting methods of the feed-in tariff.</li> </ul>

**Step 5** Bind a device through scanning the QR code on the device, manually inputting the device S/N, or uploading a QR code picture. Tap **Confirm** after the QR code is identified or the S/N is verified.

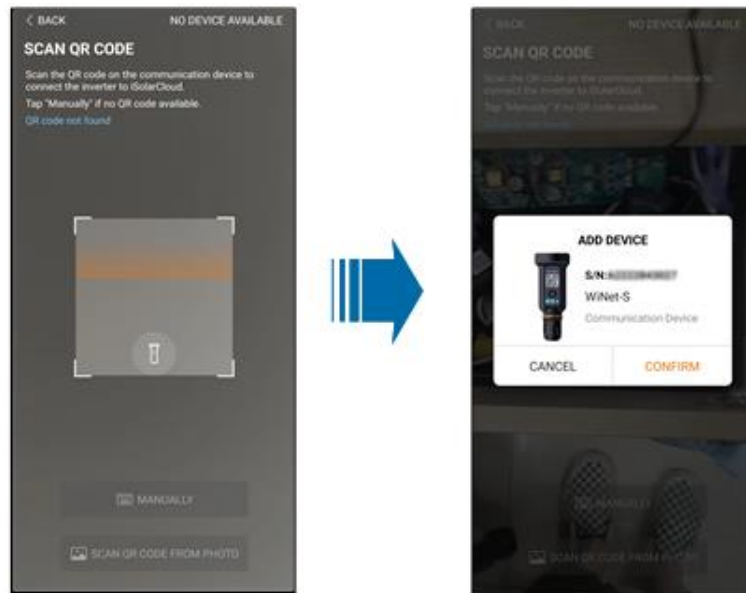

**Step 6** After a device is bound, tap **Device** and **Commissioning** to go to corresponding interface.

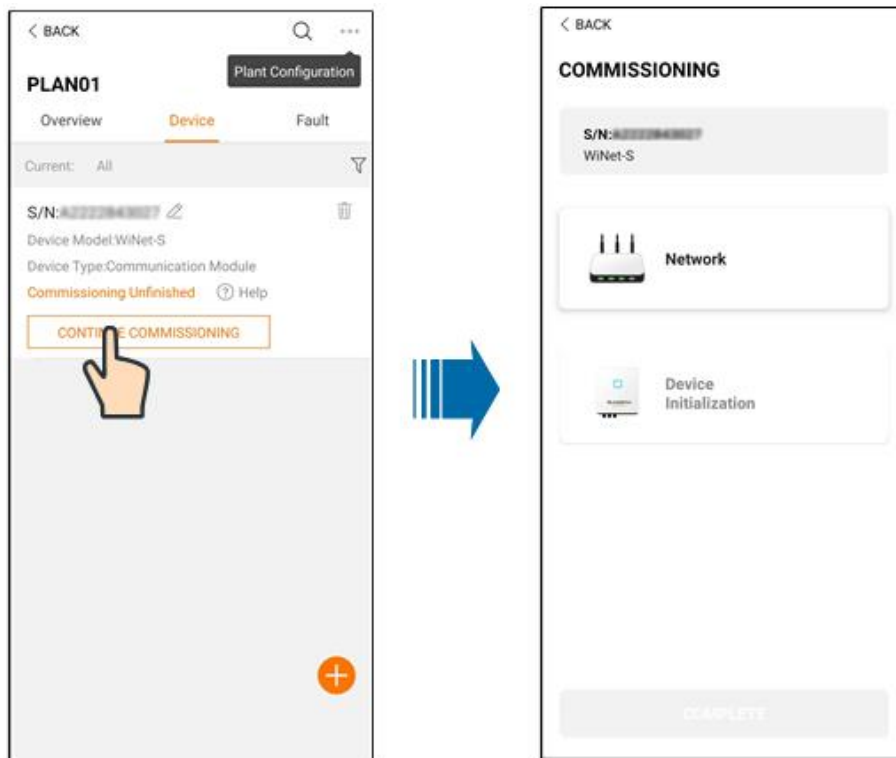

**Step 7** Tap **Network Configuration** to go to the **WLAN connection** interface. Tap the home network in the WLAN list, enter the password, and then tap **Confirm**.

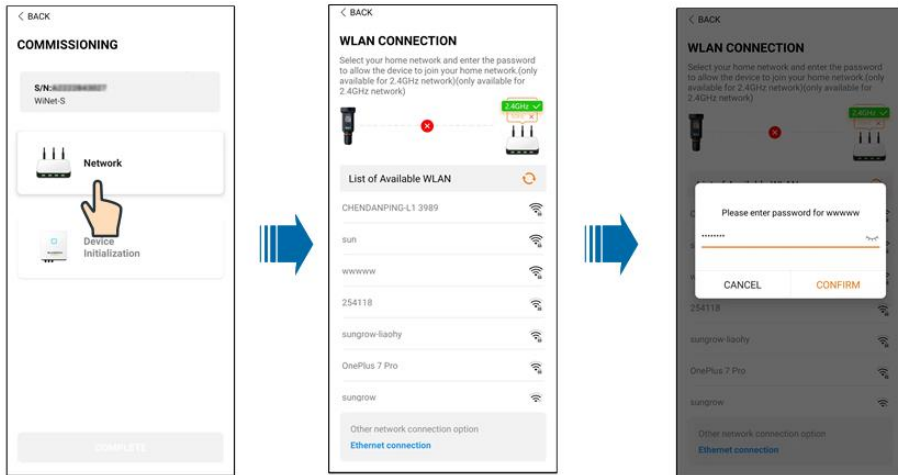

**Step 8** Enter the **Activate EasyConnect** interface, and press the multi-function button on the WiNet-S to enable the Easyconnect mode according to the prompt on the screen. The App automatically enters a waiting processing interface if this mode is enabled, and automatically returns to the commissioning interface after the processing is completed.

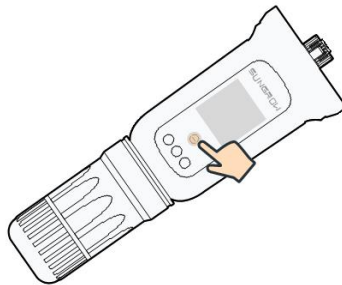

#### NOTICE

**Only the 2.4 GHz working band is supported under the networking mode.**

**If the Easyconnect fails, please refer to other methods in the WiNet-S manual to establish the connection.**

**Step 9** Tap **Device Initialization** to go to the **Device initialization** interface. Set the initialization protection parameters as needed and tap **Settings** to return to the commissioning interface.

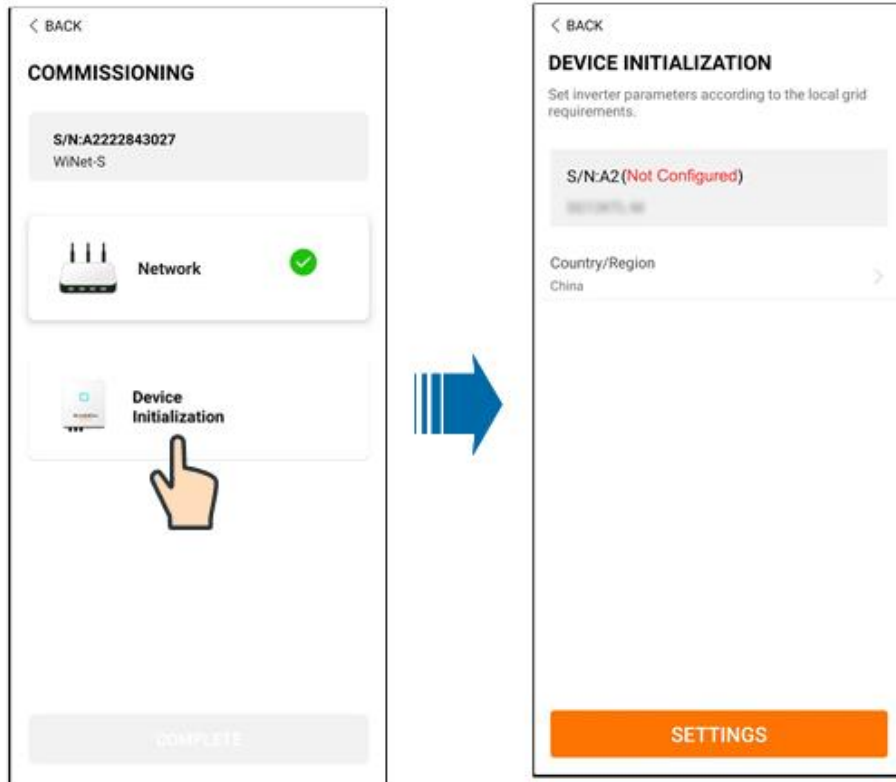

When the country is set to Australia, additionally set the applicable network service provider and then the grid type.

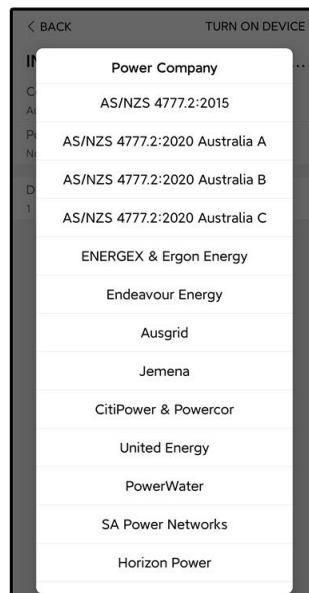

The image shown here is for reference only. Refer to the actual interface for the supported network service providers.

table 6-1 Description of Network Service Provider and Grid Type

Network Service Provider	Grid Type
AS/NZS 4777.2:2015	/
AS/NZS 4777.2:2020	/
Australia A	
AS/NZS 4777.2:2020	/
Australia B	
AS/NZS 4777.2:2020	/
Australia C	
ENERGEX & Ergon Energy	<ul style="list-style-type: none"> <li>• STNW1170: single-phase &lt; 10 kVA &amp; three-phase &lt; 30 kVA</li> <li>• STNW1174: 30 kVA &lt; <math>P_n \leq 1500</math> kVA</li> </ul>
Jemena	<ul style="list-style-type: none"> <li>• <math>\leq 10</math> kVA per phase (or 30 kVA per three phase)</li> <li>• ELE GU 0014: 30 kVA–200 kVA</li> </ul>
Endeavour Energy	MDI 0043
Ausgrid	NS194
CitiPower & Powercor	<ul style="list-style-type: none"> <li>• <math>\leq 5</math> kVA for single-phase &amp; 30 kVA for three-phase</li> <li>• &gt; 30 kVA three-phase</li> </ul>
United Energy	<ul style="list-style-type: none"> <li>• UE-ST-2008.1: <math>\leq 10</math> kVA for single-phase &amp; 30 kVA for three-phase</li> <li>• UE-ST-2008.2: &gt; 30 kVA three-phase</li> </ul>
PowerWater	Embedded Generation Notice Photovoltaic Systems:2020
SA Power Networks	<ul style="list-style-type: none"> <li>• TS129-2019: &lt; 10 kW for single-phase &amp; 30 kW for three-phase</li> <li>• TS130-2017: &gt; 30 kW &amp; <math>\leq 200</math> kW</li> <li>• TS131-2018: &gt; 200 kW</li> </ul>
Horizon Power	<ul style="list-style-type: none"> <li>• HPC-9DJ-13-0001-2019: <math>\leq 10</math>kVA for single-phase &amp; 30 kVA for three-phase</li> <li>• HPC-9DJ-13-0002-2019: &gt; 30kVA &amp; <math>\leq 1</math>MVA</li> </ul>
westernpower	EDM#33612889-2019
AusNet Services	Basic Micro Embedded Generation: 2020

\* For compliance with AS/NZS 4777.2:2020, please select from Australia A/B/C. Please contact your electricity grid operator for which region to use.



- Please check the country supported by this product at [http:// support.sungrow-power.com/](http://support.sungrow-power.com/).
- Set **Country/Region** to the country/region where the inverter is installed. Otherwise, the inverter may report a fault.

**Step 10** After a plant is successfully created, return to the App home page to view the plant information.

-- End

## 6.5 Initializing the Device

The inverter is successfully connected to the router.

If there is no latest equipment upgrade package, skip steps 1 and 2.

The actual initializing procedure may differ due to different countries. Please follow the actual App guidance.



**Step 1** If a latest equipment upgrade package is available, the following prompt window pops up. Tap **UPDATE NOW** to download the latest update package.

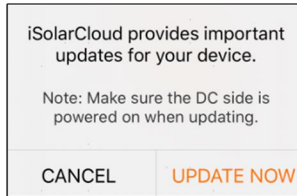

**figure 6-3** Upgrade Reminder

**Step 2** After download, it would take around 15 minutes to update. After successful upgrade, the screen will show the version numbers before and after the upgrade as well as the upgrade time. Tap **NEXT**.

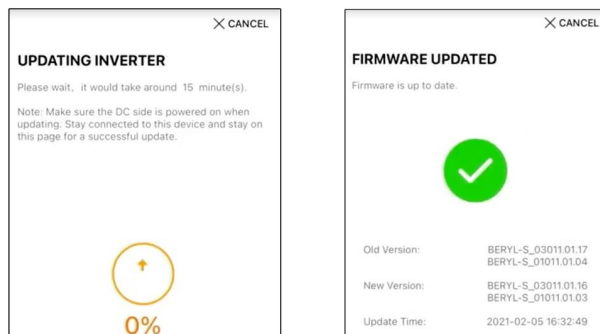

**figure 6-4** Upgrading Inverter

#### NOTICE

**If the communication equipment is upgraded, after successful upgrade, check and confirm that the phone is connected to the inverter WLAN.**

**Step 3** Tap **Country/Region** and select the country where the inverter is installed at. The supported countries and corresponding settings are as follows.

Country/Region	Setting
Belgium ("BE")	Belgium
Netherlands ("NL")	Netherlands
Portugal / Turkey / Hungary / Romania / Greece / Lithuania	EN50549-1, with proper manual settings
Poland ("PL")	Poland
United Kingdom	United Kingdom
	United Kingdom_G98
France	France
Italy	Italy
Spain	Spain
Australia ("AU")	Australia
New Zealand ("NZ")	New Zealand
Countries not listed above	Other 50Hz or Other 60Hz

#### NOTICE

**The parameter Country/Region must be set to the country (region) where the inverter is installed at. Otherwise, the inverter may report errors.**

**Step 4** When the country is set to Australia, additionally set the applicable network service provider and then the grid type.

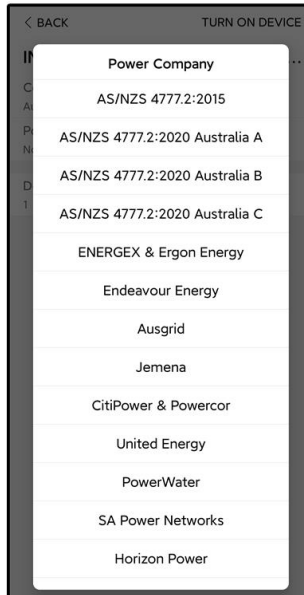

The image shown here is for reference only. Refer to the actual interface for the supported network service providers.

table 6-2 Description of Network Service Provider and Grid Type

Network Service Provider	Grid Type
AS/NZS 4777.2:2015	/
AS/NZS 4777.2:2020	/
Australia A	/
AS/NZS 4777.2:2020	/
Australia B	/
AS/NZS 4777.2:2020	/
Australia C	/
ENERGEX & Ergon Energy	<ul style="list-style-type: none"> <li>• STNW1170: single-phase &lt; 10 kVA &amp; three-phase &lt; 30 kVA</li> <li>• STNW1174: 30 kVA &lt; P<sub>n</sub> ≤ 1500 kVA</li> </ul>
Jemena	<ul style="list-style-type: none"> <li>• ≤ 10 kVA per phase (or 30 kVA per three phase)</li> <li>• ELE GU 0014: 30 kVA–200 kVA</li> </ul>
Endeavour Energy	MDI 0043
Ausgrid	NS194

Network Service Provider	Grid Type
CitiPower & Powercor	<ul style="list-style-type: none"> <li>• <math>\leq 5</math> kVA for single-phase &amp; 30 kVA for three-phase</li> <li>• <math>&gt; 30</math> kVA three-phase</li> </ul>
United Energy	<ul style="list-style-type: none"> <li>• UE-ST-2008.1: <math>\leq 10</math> kVA for single-phase &amp; 30 kVA for three-phase</li> <li>• UE-ST-2008.2: <math>&gt; 30</math> kVA three-phase</li> </ul>
PowerWater	Embedded Generation Notice Photovoltaic Systems:2020
SA Power Networks	<ul style="list-style-type: none"> <li>• TS129-2019: <math>&lt; 10</math> kW for single-phase &amp; 30 kW for three-phase</li> <li>• TS130-2017: <math>&gt; 30</math> kW &amp; <math>\leq 200</math> kW</li> <li>• TS131-2018: <math>&gt; 200</math> kW</li> </ul>
Horizon Power	<ul style="list-style-type: none"> <li>• HPC-9DJ-13-0001-2019: <math>\leq 10</math>kVA for single-phase &amp; 30 kVA for three-phase</li> <li>• HPC-9DJ-13-0002-2019: <math>&gt; 30</math>kVA &amp; <math>\leq 1</math>MVA</li> </ul>
westernpower	EDM # 33612889-2019
AusNet Services	Basic Micro Embedded Generation: 2020

\* For compliance with AS/NZS 4777.2:2020, please select from Australia A/B/C. Please contact your electricity grid operator for which region to use.

**Step 5** Initialize parameters according to local grid requirements, including grid type, reactive power regulation mode, etc. The screen displays that the inverter is successfully configured.

The screenshot shows a configuration screen with the following parameters:

- Country/Region: Netherlands
- Grid Type: Low Voltage
- Feed-in Limitation:
- Feed-in Limitation Value: 20.00 kW
- Feed-in Limitation Ratio: 100.0 %
- Reactive Power Regulation Mode: Off
- Reactive Power Ratio:

At the bottom of the screen is an orange button labeled "NEXT".

figure 6-5 Initializing Parameters

-- End

## 6.6 Configuring the Plant

The inverter is successfully added to the plant and initialized. Refer to the guidance in previous sections.

The distributor/installer who creates a plant for the end user needs to get the end user's e-mail address. In configuring a plant, the e-mail address is required, and each e-mail address can be registered only once.

**Step 1** The App screen will display the added inverter. Tap **NEXT** to configure the plant.

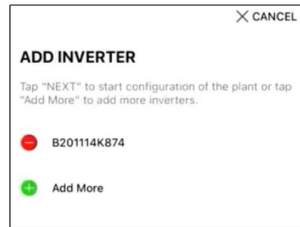

**figure 6-6** Display the Added Inverter

**Step 2** Fill in the plant information. The fields marked with \* must be filled in.

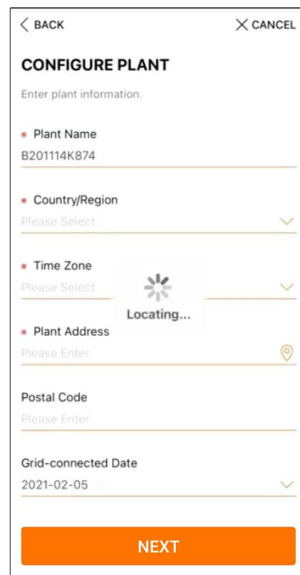

**figure 6-7** Entering Plant Information

**Step 3 (Optional)** Fill in the tariff information. The electricity price can be set to a specific value or Time-of-Use tariff.

**figure 6-8** Entering Tariff Information

**Step 4** Fill in the end user's e-mail address. The first time you fill in the end user's e-mail address, the system will create an account for the end user and send an email to the end user. The end user can activate the account via the email.



The Distributor/installer creates plants for the end user and can manage the plants by default.

**figure 6-9** Entering Owner's e-mail

**Step 5** Tap **NEXT** to wait for the inverter to connect to the iSolarCloud.

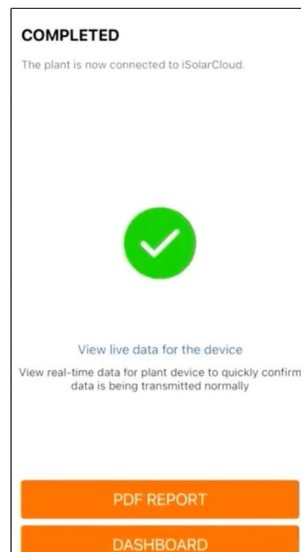

figure 6-10 Configuration Completed

**Step 6 (Optional)** Tab **View live data for the device**, tick **Inverter** or **Total Plant Devices** and tab **ALL PLANTS OPEN**. The clock symbol indicates that the live data view function is successfully enabled. Tab the inverter to view the live data about voltage, current, power or curve.

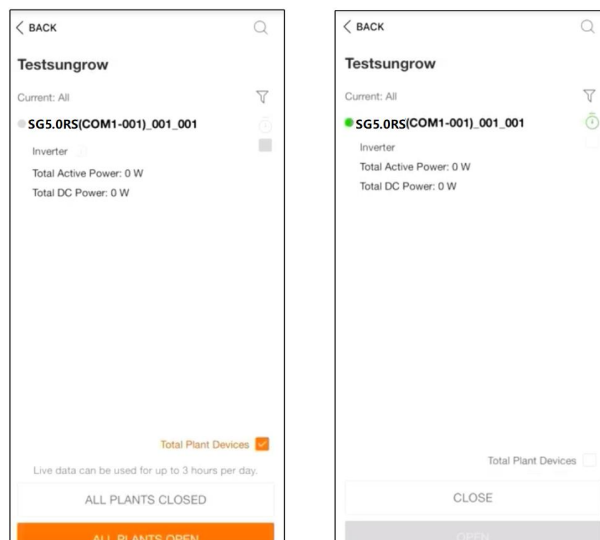

figure 6-11 Live Data View Function Setting



Contact Sungrow service to enable live data function of devices. Once enabled, live data function is available for 3 hours per day by default. To make it available for 24 hours, contact SUNGROW.

**Step 7** Tab **BACK** to the **COMPLETED** screen. Tab **PDF REPORT** to export the plant configuration report.



**Step 8** Tab **BACK** to the **COMPLETED** screen. Tab **DASHBOARD** to return and manually refresh the page until the newly created plant is displayed with status commissioned.

-- End

## 6.7 Optimizer Physical Layout (Optional)

- If PV modules are installed and optimizers are configured, check to ensure that all devices are reliably installed.
- Remove QR code labels from the optimizers and attach them to corresponding square cells on the physical layout.
- Please refer to the optimizer user manual for details of the optimizer physical layout.



# 7 iSolarCloud App

## 7.1 Brief Introduction

The iSolarCloud App can establish communication connection to the inverter via the WLAN, providing remote monitoring, data logging and near-end maintenance on the inverter. Users can also view inverter information and set parameters through the App.

\* To achieve direct login via WLAN, the wireless communication module developed and manufactured by SUNGROW is required. The iSolarCloud App can also establish communication connection to the inverter via Ethernet connection.



- This manual describes only how to achieve near-end maintenance via WLAN direct connection.
- Screenshots in this manual are based on the V2.1.6 App for Android system, and the actual interfaces may differ.

## 7.2 Installing App

### Method 1

Download and install the App through the following application stores:

- MyApp (Android, mainland China users)
- Google Play (Android, users other than mainland China ones)
- App Store (iOS)

### Method 2

Scan the following QR code to download and install the App according to the prompt information.



The App icon appears on the home screen after installation.



### 7.3 Account Registration

The account distinguishes two user groups, end user and distributor/installer.

- The end user can view plant information, create plants, set parameters, share plants, etc.
- The distributor/installer can help the end user to create plants, manage, install, or maintain plants, and manage users and organizations.

**Step 1** Tap **REGISTER** to enter the registration screen.

**USER REGISTRATION**

**Account Type**

Please select the relevant server for your area; if not available, please select the international station

**Distributor/Installer**

Distributor/Installer is the person who install or/and manage the plant, and supply service to end user

**End User**

End User is the person who will own or has owned one inverter or more

**Step 2** Select the relevant server for your area.

**Step 3** Select **End user** or **Distributor/Installer** to enter the corresponding screen.

**Step 4** Fill in the registration information, including email, verification code, password and affirmand country (region). The distributor/installer has the permission to fill in the company name and the code of upper level installer/distributor.



The code of upper level distributor/installer can be obtained from the upper level distributor/installer. Only when your organization belongs to the upper level distributor/installer organization, can you fill in the corresponding code.

**Step 5** Tick **Accept privacy protocol** and tap **Register** to finish the registration operation.

-- End

## 7.4 Login

### 7.4.1 Requirements

The following requirements should be met:

- The AC or DC side of the inverter is powered-on.
- The WLAN function of the mobile phone is enabled.
- The mobile phone is within the coverage of the wireless network produced by the communication module.

## 7.4.2 Login Procedure

**Step 1** For the WiNet-S module, press the multi-function button 3 times to enable the WLAN hotspot. No password is required and the valid time is 30 minutes.

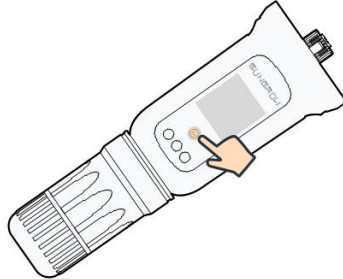

**figure 7-1** Enabling the WLAN Hotspot

**Step 2** Connect the mobile phone to the WLAN network named as "SG-xxxxxxxxxx" (xxxxxxxxxx is the serial number indicated on the side of the communication module).

**Step 3** Open the App to enter the login screen. Tap **Local Access** to enter the next screen.

**Step 4** Tap **Confirm**, then enter the password and tap **LOGIN**. Or tap **MANUAL CONNECTION** at the bottom of the interface and select **WiNet-S**, then enter the password and tap **LOGIN**.



- If the WiFi signal, serial number or inverter related data information cannot be found, unplug and reinsert the WiNet-S or press the multi-function button of the WiNet-S three times.
- The default account is "user" and the initial password is "pw1111" which should be changed for the consideration of account security. Tap "More" at the lower right corner on home page and choose "Change Password".

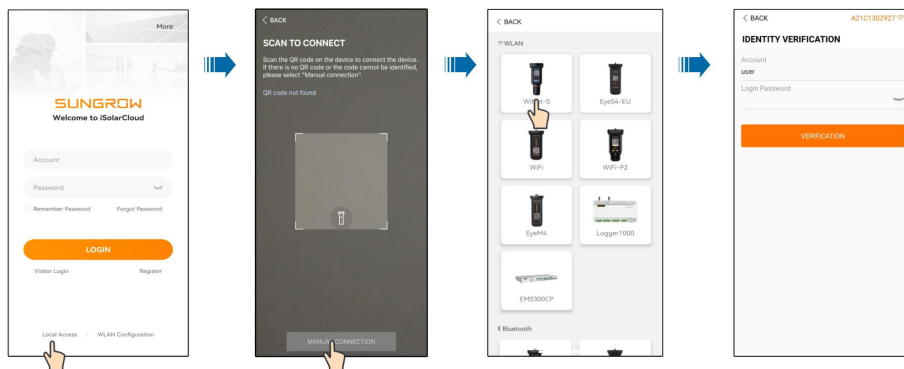

figure 7-2 WLAN Local Access

**Step 5** If the inverter is not initialized, navigate to the quick setting screen to initialize the protection parameters. For details, please refer to "Initial Settings".

#### NOTICE

The "Country/Region" must be set to the country where the inverter is installed at. Otherwise, the inverter may report errors.

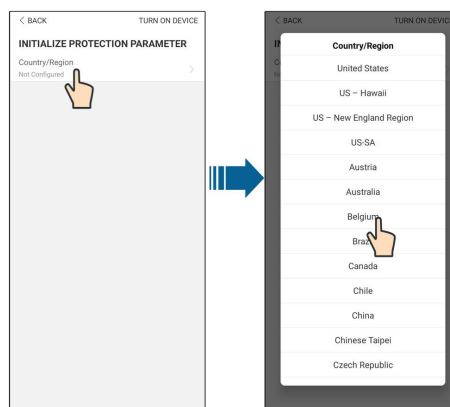

figure 7-3 WLAN Local Access

**Step 6** After finishing the settings, tap **TURN ON DEVICE** at the upper right corner and the device will be initialized. The App will send start instructions and the device will start and operate.

**Step 7** After initialization settings, the App will return automatically to the home page.

-- End

## 7.5 Initial Settings

Tap **Country/Region** and select the country where the inverter is installed. For countries except Australia and Germany, the initialization is completed.



The actual initializing procedure may differ due to different countries. Please follow the actual App guidance.



For some countries, you should initialize parameters according to local grid requirements. For details, please refer to the relevant technical documents on <http://support.sungrowpower.com/>.

## 7.6 Function Overview

The App provides parameter viewing and setting functions, as shown in the following figure.

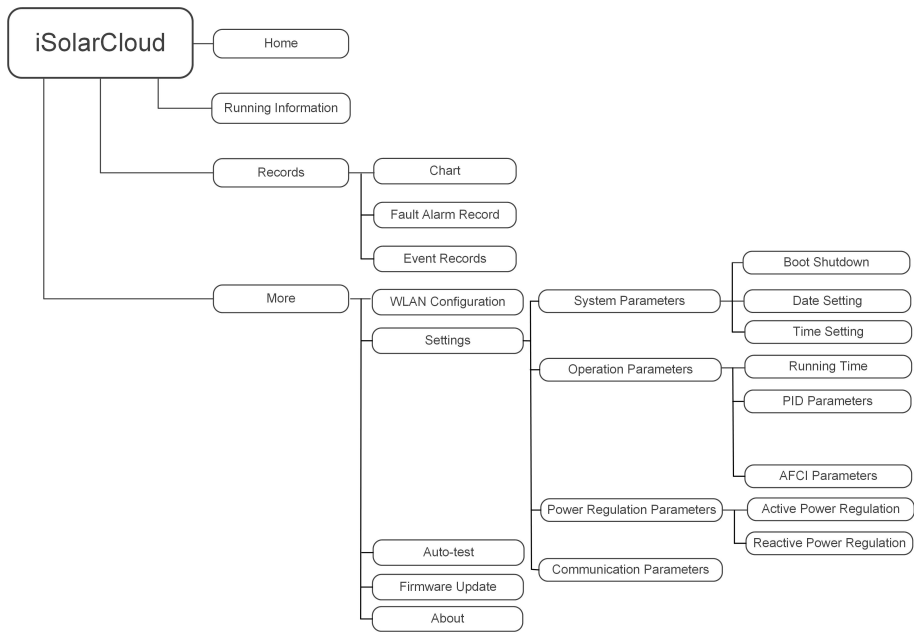

figure 7-4 App Function Tree Map

## 7.7 Home

Home page of the App is shown in the following figure.



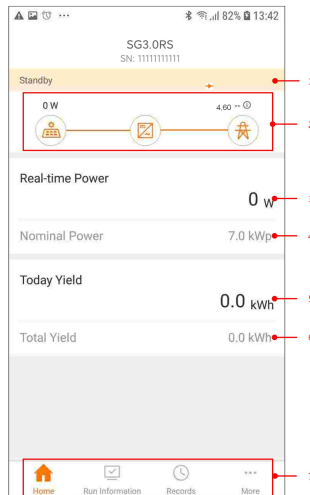



figure 7-5 Home

table 7-1 Home Page Description

No.	Name	Description
1	Inverter state	Present operation state of the inverter
2	Energy flow chart	Shows the PV power generation power, feed-in power, etc. The line with an arrow indicates energy flow between connected devices, and the arrow pointing indicates energy flow direction.
3	Real-time power	Shows the present output power of the inverter.
4	Nominal power	Shows the installed power of the inverter.
5	Today yield	Shows today power generation of the inverter
6	Total yield	Shows accumulative power generation of the inverter
7	Navigation bar	Includes menus of "Home", "Run Information", "Records" and "More".

If the inverter runs abnormally, the fault icon  will appear on the upper left corner of the screen. Users can tap the icon to view detailed fault information and corrective measures.

## 7.8 Run Information

Tap **Run Information** on the navigation bar to enter the screen showing running information, slide the screen upwards to view all detailed information.

table 7-2 Description of Run Information

Item	Description
PV information	Shows voltage and current of every PV string.
Inverter information	Shows basic information such as running state, on-grid running time, negative voltage to grid, bus voltage, internal air temperature, inverter efficiency, etc.
Input	Shows total DC power, voltage and current of MPPT1 and MPPT2.
Output	Shows daily/monthly/annual/total yield, total active/reactive/apparent power, total power factor, grid frequency, phase voltage and current.
Grid information	Shows daily/total feed-in energy, daily/total purchased energy.

## 7.9 Records

Tap **Records** on the navigation bar to enter the screen showing event records, as shown in the following figure.

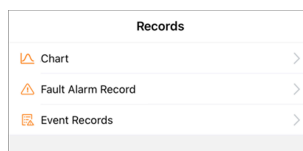

figure 7-6 Records

### Chart

Tap **Chart** to enter the screen showing daily power generation, as shown in the following figure.



figure 7-7 Chart

The App displays power generation records in a variety of forms, including daily power generation graph, monthly power generation histogram, annual power generation histogram and total power generation histogram.

table 7-3 Description of Power Curve

Item	Description
Daily	Daily curve that indicates the real-time power.
Month	Monthly curve that indicates daily yield and equivalent hours in a month.
Year	Annual curve that indicates monthly yield and equivalent hours in a year.
Total	A curve that indicates annual yield and equivalent hours since installation.

### Fault Alarm Record

Tap **Fault Alarm Record** to enter the screen, as shown in the following figure.

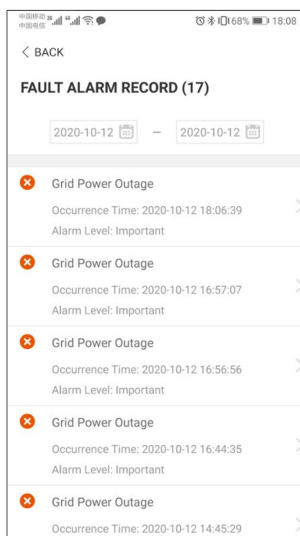
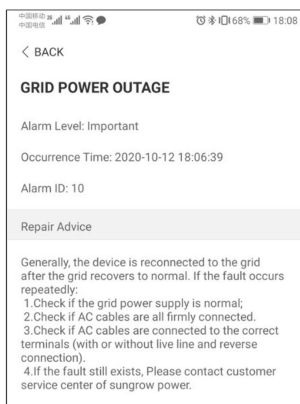

**figure 7-8** Fault Alarm Record



Click  to select a time segment and view corresponding records.

Select one of the records in the list and click the record, to view the detailed fault info as shown in following figure.



**figure 7-9** Detailed Fault Alarm Information

### Event Record

Tap **Event Record** to enter the screen, as shown in the following figure.

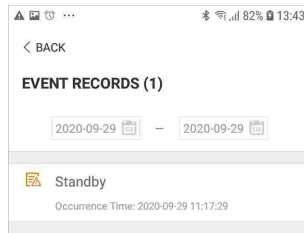



figure 7-10 Event Record



Click  to select a time segment and view corresponding records.

## 7.10 More

Tap **More** on the navigation bar to enter the corresponding screen, as shown in the following figure.

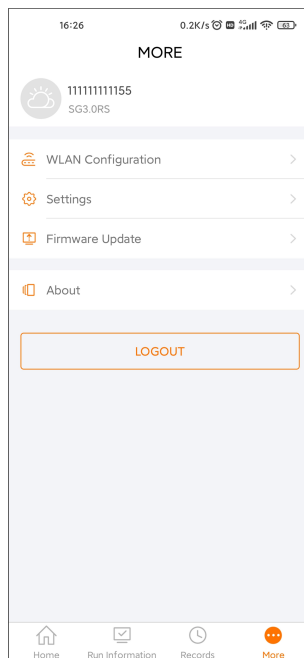

figure 7-11 More

In addition to viewing the WLAN configuration and App software version, the **More** screen supports the following operations:

- Set parameters including inverter system parameters, operation parameters, power regulation parameters and communication parameters.
- Upgrade inverter firmware.

### 7.10.1 System Parameters

Tap **“Settings→System Parameters”** to enter the corresponding interface, as shown in the following figure.

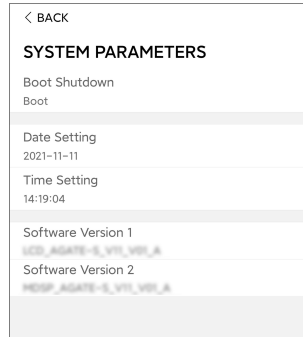

figure 7-12 System Parameters

\* The image shown here is for reference only.

#### Boot/Shutdown

Tap **Boot/Shutdown** to send the boot/shutdown instruction to the inverter.

For Australia and New Zealand, when the DRM state is DRM0, the "Boot" option will be prohibited.

#### Date Setting/Time Setting

The correct system time is very important. Wrong system time will directly affect the data logging and power generation value. The clock is in 24-hour format.

#### Software Version

Version information of the current firmware.

### 7.10.2 Operation Parameters

#### Running Time

Tap **“Settings→Operation Parameters→Running Time”** to enter the corresponding screen, on which you can set "Connecting Time" and "Reconnecting Time".

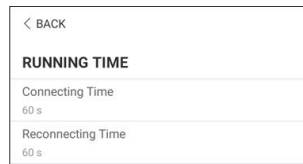

figure 7-13 Running Time

#### PID Parameters

Tap **“Settings→Operation Parameters→PID Parameters”** to enter the corresponding screen, on which you can set "PID Parameters".

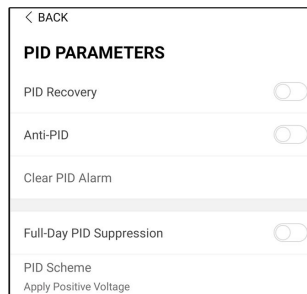

figure 7-14 PID Setting

table 7-4 PID Parameter Description

Parameter	Description
PID Recovery	Set enabling/disabling of the PID night recovery function. PID night recovery function operates between 22:00 pm and 5:00 am by default.
Anti-PID	The Anti-PID function is performed during the day when connected to the grid.
Full-Day PID Suppression	The function is turned on and the PID is adjusted throughout the day.

#### AFCI Parameters(Optional)

Tap “**Settings**→**Operation Parameters**→**AFCI Parameters**” to enter the corresponding screen, on which you can set "AFCI Parameters".

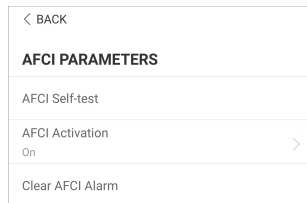

figure 7-15 AFCI Setting

### 7.10.3 Power Regulation Parameters

#### Active Power Regulation

Tap “**Settings**→**Power Regulation Parameters**→**Active Power Regulation**” to enter the screen, as shown in the following figure.

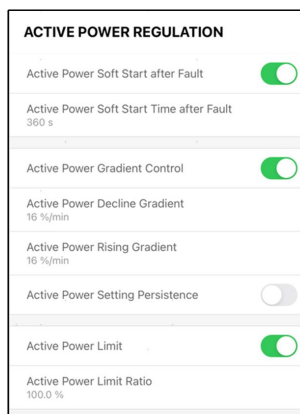

figure 7-16 Active Power Regulation

table 7-5 Description of Active Power Regulation Parameters

Parameter	Description	Range
<b>Active Power Soft Start after Fault</b>	Switch for activating/deactivating the function of active power soft start after a fault occurs	On/Off
<b>Active Power Soft Start Time after Fault</b>	The soft start time required for raising active power from 0 to rated value after a fault occurs	1 s–1200 s
<b>Active Power Gradient Control</b>	Set whether to enable active power gradient control	On/Off
<b>Active Power Decline Gradient</b>	Decline gradient of inverter active power per minute	1 %/min–6000 %/min
<b>Active Power Rising Gradient</b>	Rising gradient of inverter active power per minute	1 %/min–6000 %/min
<b>Active Power Setting Persistence</b>	Switch for activating/deactivating the function of active power setting persistence	On/Off
<b>Active Power Limit</b>	Switch for limiting active power	On/Off
<b>Active Power Limit Ratio</b>	The ratio of active power limit to rated power in percentage	0.0 %–100.0 %

### Reactive Power Regulation

Tap “**Settings**→**Power Regulation Parameters**→**Reactive Power Regulation**” to enter the screen, as shown in the following figure.





figure 7-17 Reactive Power Regulation

table 7-6 Description of Reactive Power Regulation Parameters

Parameter	Description	Range
<b>Reactive Power Setting Persistence</b>	Switch for activating/deactivating the function of reactive power setting persistence	On/Off
<b>Reactive Power Regulation Mode</b>	Off/PF/Qt/Q(P)/Q(U)	Off/PF/Qt/Q(P)/Q(U)
<b>Reactive Response</b>	Switch for activating/deactivating the function of reactive response	On/Off
<b>Reactive Response Time</b>	Time for reactive response	0.1 s-600 s

#### "Off" Mode

The reactive power regulation function is disabled. The PF is fixed at +1.000.

#### "PF" Mode

The power factor (PF) is fixed and the reactive power is regulated by the parameter PF. The PF ranges from 0.8 leading to 0.8 lagging.

- Leading: the inverter is sourcing reactive power to the grid.
- Lagging: the inverter is injecting reactive power into the grid.

#### "Qt" Mode

In the Qt mode, the reactive power can be regulated by the parameter Q-Var limits (in %). The system rated reactive power is fixed, the system injects reactive power according to the delivered reactive power ratio. The "Reactive Power Ratio" is set through the App.

The setting range of the reactive power ratio is from -100 % to 100 %, corresponding to the ranges of inductive and capacitive reactive power regulation respectively.

#### "Q(P)" Mode

The PF of the inverter output varies in response to the output power of the inverter.

table 7-7 "Q(P)" Mode Parameters Explanation

Parameter	Explanation	Range
Q(P) Curve	Select corresponding curve according to local regulations	A, B, C*
QP_P1	Output power at point P1 on the Q(P) mode curve (in %)	0.0 %–100.0 %
QP_P2	Output power at point P2 on the Q(P) mode curve (in %)	20.0 %–100.0 %
QP_P3	Output power at point P3 on the Q(P) mode curve (in %)	20.0 %–100.0 %
QP_K1	Power factor at point P1 on the Q(P) mode curve	Curve A/C: 0.800 to 1.000
QP_K2	Power factor at point P2 on the Q(P) mode curve	Curve B: -0.600 to 0.600
QP_K3	Power factor at point P3 on the Q(P) mode curve	
QP_EnterVoltage	Voltage for Q(P) function activation (in %)	100.0 %–110.0 %
QP_ExitVoltage	Voltage for Q(P) function deactivation (in %)	90.0 %–100.0 %
QP_ExitPower	Power for Q(P) function deactivation (in %)	1.0 %–100.0 %
QP_EnableMode	Unconditional activation/deactivation of Q(P) function	Yes, No

\* Curve C is reserved and consistent with Curve A currently.

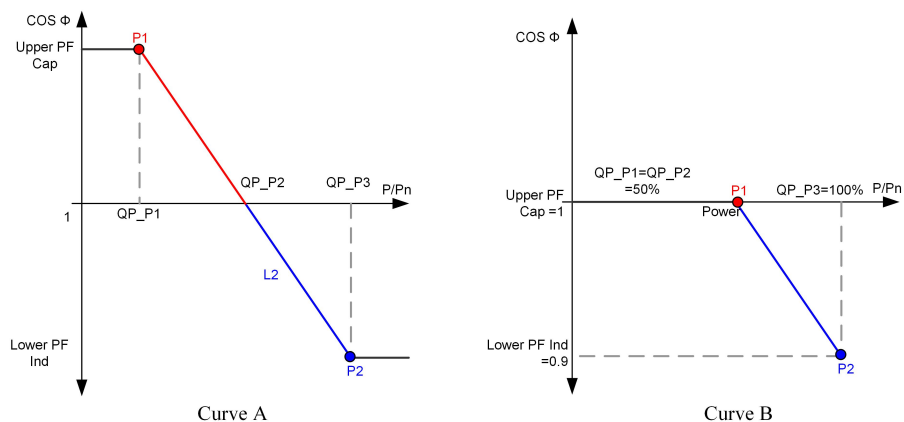

figure 7-18 Reactive Power Regulation Curve in Q(P) Mode

### "Q(U)" Mode

The reactive power output of the inverter varies in response to the grid voltage.

table 7-8 "Q(U)" Mode Parameter Explanation

Parameter	Explanation	Range
Q(U) curve	Select corresponding curve according to local regulations	A, B, C*
Hysteresis Ratio	Voltage hysteresis ratio on the Q(U) mode curve	0.0 %–5.0 %
QU_V1	Grid voltage limit at point P1 on the Q(U) mode curve (in %)	80.0 %–100.0 %
QU_V2	Grid voltage limit at point P2 on the Q(U) mode curve (in %)	80.0 %–100.0 %
QU_V3	Grid voltage limit at point P3 on the Q(U) mode curve (in %)	100.0 %–120.0 %
QU_V4	Grid voltage limit at point P4 on the Q(U) mode curve (in %)	100.0 %–120.0 %
QU_Q1	Value of Q/Sn at point P1 on the Q(U) mode curve (in %)	-60.0 % to 0.0 %
QU_Q2	Value of Q/Sn at point P2 on the Q(U) mode curve (in %)	-60.0 % to 60.0 %
QU_Q3	Value of Q/Sn at point P3 on the Q(U) mode curve (in %)	-60.0 % to 60 %
QU_Q4	Value of Q/Sn at point P4 on the Q(U) mode curve (in %)	0.0 % to 60.0 %
QU_EnterPower	Active power for Q(U) function activation (in %)	20.0 %–100.0 %
QU_ExitPower	Active power for Q(U) function deactivation (in %)	1.0 %–20.0 %
QU_EnableMode	Unconditional activation/deactivation of Q(U) function	Yes, No, Yes (Limited by PF)
QU_Limited PF Value	Preset PF value	0–1

\* Curve C is reserved and consistent with Curve A currently.

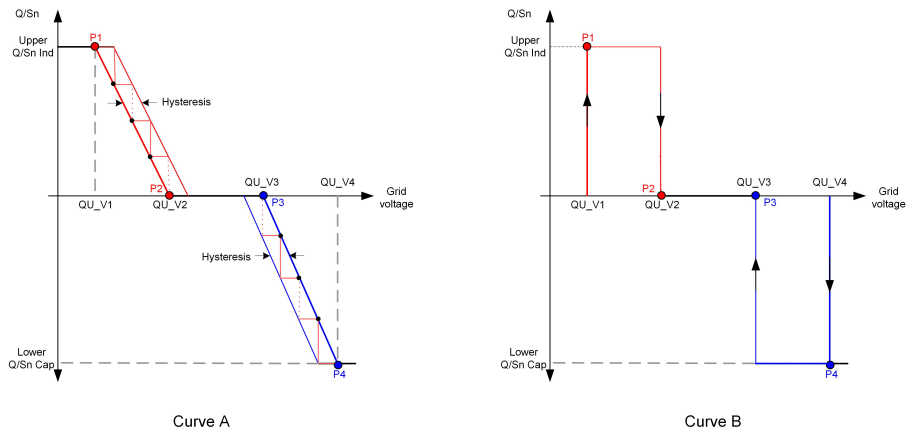

figure 7-19 Reactive Power Regulation Curve in Q(U) Curve

### 7.10.4 Communication Parameters

Tap “**Settings**→**Communication Parameters**” to enter the corresponding screen, as shown in the following figure. The device address ranges from 1 to 246.

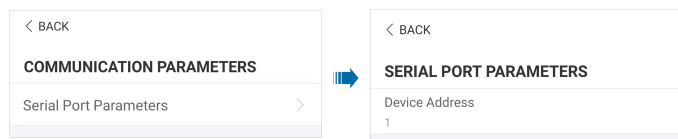

figure 7-20 Communication Parameters

### 7.10.5 Firmware Update

To avoid download failure due to poor on-site network signal, it is recommended to download the firmware package to the mobile device in advance.

**Step 1** Enable the "Mobile data" of the mobile device.

**Step 2** Open the App, enter the account and password on the login screen. Tap **Login** to enter the home screen.

**Step 3** Tap “**More**→**Firmware Download**” to enter corresponding screen on which you can view the device list.

**Step 4** Select the device model before downloading the firmware. Tap the device name in the device list to enter the firmware upgrade package detail interface, and tap  behind the firmware upgrade package to download it.

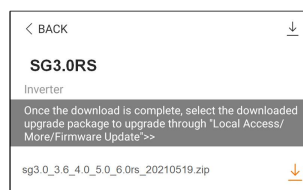

**Step 5** Return to the **Firmware Download** screen, tap  in the upper right corner of the screen to view the downloaded firmware upgrade package.

**Step 6** Login the App via local access mode. Refer to "7.4 Login".

**Step 7** Tap **More** on the App home screen and then tap **Firmware Update**.

**Step 8** Tap the upgrade package file, a prompt box will pop up asking you to upgrade the firmware with the file, tap **CONFIRM** to perform the firmware upgrade.

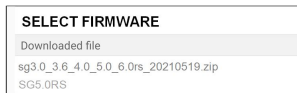

**Step 9** Wait for the file to be uploaded. When the upgrade is finished, the interface will inform you of the upgrade completion. Tap **Complete** to end the upgrade.

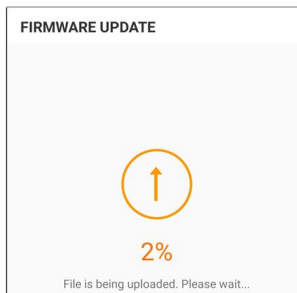

-- End

### 7.10.6 Auto-test

Tap "**Auto-test**" to enter the corresponding screen, as shown in the following figure.

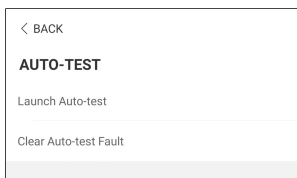

figure 7-21 Auto-test

#### Launch Auto-test

Tap **Launch Auto-test** carry out an auto-test. Auto-testing will take about 5 minutes. When the auto-test is completed, the auto-test report is displayed, as shown in the figure below.

Tap **DOWNLOAD** to download the report.

AUTO-TEST RESULT	
Auto-test Result	Successful
Over-frequency Level 1 (81>.S1)	
Over-frequency Level 1 (81>.S1)	Successful
Frequency Threshold	51.50 Hz
Frequency Sample Value	50.00 Hz
Time Threshold	0.10 s
Time Sample Value	0.10 s
Under Frequency Level 1 (81<.S1)	
Under Frequency Level 1 (81<.S1)	Successful
Frequency Threshold	47.50 Hz
Frequency Sample Value	49.99 Hz
Time Threshold	0.10 s
Time Sample Value	0.10 s
Over-voltage Level 1 (59.S1)	
Over-voltage Level 1 (59.S1)	Successful
<b>DOWNLOAD</b>	

figure 7-22 Auto-test Result

### Clear Auto-test Fault

Tap “Clear Auto-test Fault→CONFIRM” to clear the auto-test fault.

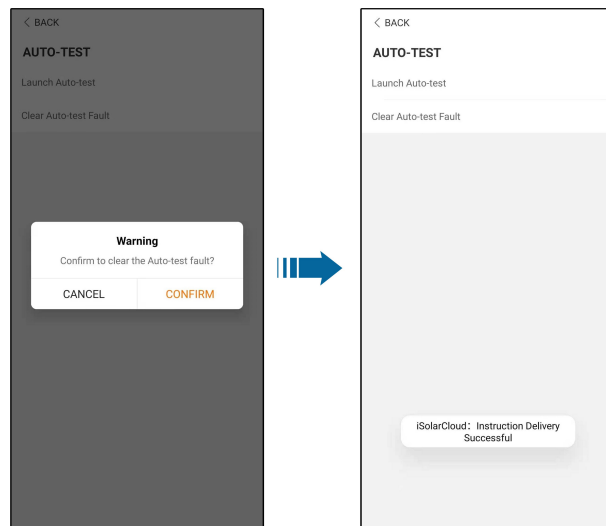

figure 7-23 Clear Auto-test Fault

## 8 System Decommissioning

### 8.1 Disconnecting Inverter

#### CAUTION

##### **Danger of burns!**

**Even if the inverter is shut down, it may still be hot and cause burns. Wear protective gloves before operating the inverter after it cools down.**

For maintenance or other service work, the inverter must be switched off.

Proceed as follows to disconnect the inverter from the AC and DC power sources. Lethal voltages or damage to the inverter will follow if otherwise.

**Step 1** Disconnect the external AC circuit breaker and prevent it from inadvertent reconnection.

**Step 2** Rotate the DC switch to the "OFF" position for disconnecting all of the PV string inputs.

**Step 3** Wait about 10 minutes until the capacitors inside the inverter completely discharge.

**Step 4** Ensure that the DC cable is current-free with a current clamp.

-- End

### 8.2 Dismantling the Inverter

#### CAUTION

##### **Risk of burn injuries and electric shock!**

**After the inverter is powered off for 10 minutes, measure the voltage and current with professional instrument. Only when there is no voltage nor current can operators who wear protective equipment operate and maintain the inverter.**



- Before dismantling the inverter, disconnect the inverter from both AC and DC power sources.
- If there are more than two layers of inverter DC terminals, dismantle the outer DC connectors before dismantling the inner ones.
- If the original packing materials are available, put the inverter inside them and then seal them using adhesive tape. If the original packing materials are not available, put the inverter inside a cardboard box suitable for the weight and size of this inverter and seal it properly.

**Step 1** Refer to "[5 Electrical Connection](#)", for the inverter disconnection of all cables in reverse steps. In particular, when removing the DC connector, use an MC4 wrench to loosen the locking parts and install waterproof plugs.

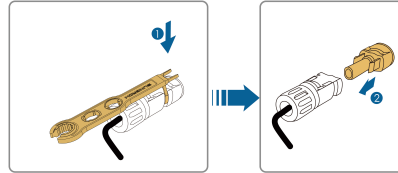

**Step 2** Refer to "[4 Mechanical Mounting](#)", to dismantle the inverter in reverse steps.

**Step 3** If necessary, remove the wall-mounting bracket from the wall.

**Step 4** If the inverter will be used again in the future, please refer to "[3.2 Inverter Storage](#)" for a proper conservation.

-- End

### 8.3 Disposal of Inverter

Users take the responsibility for the disposal of the inverter.

#### **⚠ WARNING**

**Please scrap the inverter in accordance with relevant local regulations and standards to avoid property losses or casualties.**

#### **NOTICE**

**Some parts of the inverter may cause environmental pollution. Please dispose of them in accordance with the disposal regulations for electronic waste applicable at the installation site.**



## 9 Troubleshooting and Maintenance

### 9.1 Troubleshooting

Once the inverter fails, the fault information is displayed on the App interface. If the inverter is equipped with an LCD screen, the fault information can be viewed on it.

The fault codes and troubleshooting methods of all PV inverters are detailed in the table below, and only some of the faults may occur to the model you purchased. When a fault occurs, you can check the fault information according to the fault code on the mobile app.

Fault Code	Fault Name	Corrective Measures
2, 3, 14, 15	Grid Overvoltage	<p>Generally, the inverter will be reconnected to the grid after the grid returns to normal. If the fault occurs repeatedly:</p> <ol style="list-style-type: none"><li>1. Measure the actual grid voltage, and contact the local electric power company for solutions if the grid voltage is higher than the set value.</li><li>2. Check whether the protection parameters are appropriately set via the App or the LCD. Modify the overvoltage protection values with the consent of the local electric power operator.</li><li>3. Contact Sungrow Customer Service if the preceding causes are ruled out and the fault persists.</li></ol>
4, 5	Grid Undervoltage	<p>Generally, the inverter will be reconnected to the grid after the grid returns to normal. If the fault occurs repeatedly:</p> <ol style="list-style-type: none"><li>1. Measure the actual grid voltage, and contact the local electric power company for solutions if the grid voltage is lower than the set value.</li><li>2. Check whether the protection parameters are appropriately set via the App or the LCD.</li><li>3. Check whether the AC cable is firmly in place.</li><li>4. Contact Sungrow Customer Service if the preceding causes are ruled out and the fault persists.</li></ol>

Fault Code	Fault Name	Corrective Measures
8	Grid Overfrequency	Generally, the inverter will be reconnected to the grid after the grid returns to normal. If the fault occurs repeatedly:
9	Grid Underfrequency	<ol style="list-style-type: none"> <li>1. Measure the actual grid frequency, and contact the local electric power company for solutions if the grid frequency is beyond the set range.</li> <li>2. Check whether the protection parameters are appropriately set via the App or the LCD.</li> <li>3. Contact Sungrow Customer Service if the preceding causes are ruled out and the fault persists.</li> </ol>
10	Grid Power Outage	<p>Generally, the inverter will be reconnected to the grid after the grid returns to normal. If the fault occurs repeatedly:</p> <ol style="list-style-type: none"> <li>1. Check whether the grid supplies power reliably.</li> <li>2. Check whether the AC cable is firmly in place.</li> <li>3. Check whether the AC cable is connected to the correct terminal (whether the live wire and the N wire are correctly in place).</li> <li>4. Check whether the AC circuit breaker is connected.</li> <li>5. Contact Sungrow Customer Service if the preceding causes are ruled out and the fault persists.</li> </ol>
12	Excess Leakage Current	<ol style="list-style-type: none"> <li>1. The fault can be caused by poor sunlight or damp environment, and generally the inverter will be reconnected to the grid after the environment is improved.</li> <li>2. If the environment is normal, check whether the AC and DC cables are well insulated.</li> <li>3. Contact Sungrow Customer Service if the preceding causes are ruled out and the fault persists.</li> </ol>
13	Grid Abnormal	<p>Generally, the inverter will be reconnected to the grid after the grid returns to normal. If the fault occurs repeatedly:</p> <ol style="list-style-type: none"> <li>1. Measure the actual grid, and contact the local electric power company for solutions if the grid parameter exceeds the set range.</li> <li>2. Contact Sungrow Customer Service if the preceding causes are ruled out and the fault persists.</li> </ol>

Fault Code	Fault Name	Corrective Measures
17	Grid Voltage Imbalance	<p>Generally, the inverter will be reconnected to the grid after the grid returns to normal. If the fault occurs repeatedly:</p> <ol style="list-style-type: none"> <li>1. Measure the actual grid voltage. If grid phase voltages differ greatly, contact the electric power company for solutions.</li> <li>2. If the voltage difference between phases is within the permissible range of the local power company, modify the grid voltage imbalance parameter through the App or the LCD.</li> <li>3. Contact Sungrow Customer Service if the preceding causes are ruled out and the fault persists.</li> </ol>
28, 29, 208, 212, 448-479	PV Reserve Connection Fault	<ol style="list-style-type: none"> <li>1. Check whether the corresponding string is of reverse polarity. If so, disconnect the DC switch and adjust the polarity when the string current drops below 0.5 A.</li> <li>2. Contact Sungrow Customer Service if the preceding causes are ruled out and the fault persists.</li> </ol> <p>*The code 28 to code 29 are corresponding to PV1 to PV2 respectively.</p> <p>*The code 448 to code 479 are corresponding to string 1 to string 32 respectively.</p>
532-547, 564-579	PV Reverse Connection Alarm	<ol style="list-style-type: none"> <li>1. Check whether the corresponding string is of reverse polarity. If so, disconnect the DC switch and adjust the polarity when the string current drops below 0.5 A.</li> <li>2. Contact Sungrow Customer Service if the preceding causes are ruled out and the alarm persists.</li> </ol> <p>*The code 532 to code 547 are corresponding to string 1 to string 16 respectively.</p> <p>*The code 564 to code 579 are corresponding to string 17 to string 32 respectively.</p>

Fault Code	Fault Name	Corrective Measures
548-563, 580-595	PV Abnormal Alarm	<p>Check whether the voltage and current of the inverter is abnormal to determine the cause of the alarm.</p> <ol style="list-style-type: none"> <li>1. Check whether the corresponding module is sheltered. If so, remove the shelter and ensure module cleanness.</li> <li>2. Check whether the battery board wiring is loose, if so, make it reliably connected.</li> <li>3. Check if the DC fuse is damaged. If so, replace the fuse.</li> <li>4. Contact Sungrow Customer Service if the preceding causes are ruled out and the alarm persists.</li> </ol> <p>*The code 548 to code 563 are corresponding to string 1 to string 16 respectively.</p> <p>*The code 580 to code 595 are corresponding to string 17 to string 32 respectively.</p>
37	Excessively High Ambient Temperature	<p>Generally, the inverter will resume operation when the internal or module temperature returns to normal. If the fault persists:</p> <ol style="list-style-type: none"> <li>1. Check whether the ambient temperature of the inverter is too high;</li> <li>2. Check whether the inverter is in a well-ventilated place;</li> <li>3. Check whether the inverter is exposed to direct sunlight. Shield it if so;</li> <li>4. Check whether the fan is running properly. Replace the fan if not;</li> <li>5. Contact Sungrow Power Customer Service if the fault is due to other causes and the fault persists.</li> </ol>
43	Excessively Low Ambient Temperature	<p>Stop and disconnect the inverter. Restart the inverter when the ambient temperature rises within the operation temperature range.</p>

Fault Code	Fault Name	Corrective Measures
39	Low System Insulation Resistance	<p>Wait for the inverter to return to normal. If the fault occurs repeatedly:</p> <ol style="list-style-type: none"> <li>1. Check whether the ISO resistance protection value is excessively high via the app or the LCD, and ensure that it complies with the local regulations.</li> <li>2. Check the resistance to ground of the string and DC cable. Take corrective measures in case of short circuit or damaged insulation layer.</li> <li>3. If the cable is normal and the fault occurs on rainy days, check it again when the weather turns fine.</li> <li>4. If there are batteries, check whether battery cables are damaged and whether terminals are loose or in poor contact. If so, replace the damaged cable and secure terminals to ensure a reliable connection.</li> <li>5. Contact Sungrow Customer Service if the preceding causes are ruled out and the fault persists.</li> </ol>
106	Grounding Cable Fault	<ol style="list-style-type: none"> <li>1. Check whether the AC cable is correctly connected.</li> <li>2. Check whether the insulation between the ground cable and the live wire is normal.</li> <li>3. Contact Sungrow Customer Service if the preceding causes are ruled out and the fault persists.</li> </ol>
88	Electric Arc Fault	<ol style="list-style-type: none"> <li>1. Disconnect the DC power supply, and check whether any DC cable is damaged, the connection terminal or fuse is loose or there is a weak contact. If so, replace the damaged cable, fasten the terminal or fuse, and replace the burnt component.</li> <li>2. After performing step 1, reconnect the DC power supply, and clear the electric arc fault via the App or the LCD, after that the inverter will return to normal.</li> <li>3. Contact Sungrow Customer Service if the fault persists.</li> </ol>

Fault Code	Fault Name	Corrective Measures
84	Reverse Connection Alarm of the Meter/CT	<ol style="list-style-type: none"> <li>1. Check if the meter is wrongly connected.</li> <li>2. Check if the input and output wiring of the meter is reversed.</li> <li>3. If the existing system is enabled, please check if the rated power setting of the existing inverter is correct.</li> </ol>
514	Meter Communication Abnormal Alarm	<ol style="list-style-type: none"> <li>1. Check whether the communication cable and the terminals are abnormal. If so, correct them to ensure reliable connection.</li> <li>2. Reconnect the communication cable of the meter.</li> <li>3. Contact Sungrow Customer Service if the preceding causes are ruled out and the alarm persists.</li> </ol>
323	Grid Confrontation	<ol style="list-style-type: none"> <li>1. Check whether the output port is connected to actual grid. Disconnect it from the grid if so.</li> <li>2. Contact Sungrow Customer Service if the preceding causes are ruled out and the fault persists.</li> </ol>
75	Inverter Parallel Communication Alarm	<ol style="list-style-type: none"> <li>1. Check whether the communication cable and the terminals are abnormal. If so, correct them to ensure reliable connection.</li> <li>2. Reconnect the communication cable of the meter.</li> <li>3. Contact Sungrow Customer Service if the preceding causes are ruled out and the alarm persists.</li> </ol>

Fault Code	Fault Name	Corrective Measures
7, 11, 16, 19–25, 30–34, 36, 38, 40–42, 44–50, 52–58, 60–69, 85, 87, 92, 93, 100–105, 107–114, 116–124, 200–211, 248–255, 300–322, 324–328, 401–412, 600–603, 605, 608, 612, 616, 620, 622–624, 800, 802, 804, 807, 1096–1122	System Fault	<ol style="list-style-type: none"> <li>1. Wait for the inverter to return to normal.</li> <li>2. Disconnect the AC and DC switches, and disconnect the battery side switches if there are batteries. Close the AC and DC switches in turn 15 minutes later and restart the system.</li> <li>3. Contact Sungrow Customer Service if the preceding causes are ruled out and the fault persists.</li> </ol>
59, 70–74, 76–83, 89, 216–218, 220–233, 432–434, 500–513, 515–518, 635–638, 900, 901, 910, 911, 996	System Alarm	<ol style="list-style-type: none"> <li>1. The inverter can continue running.</li> <li>2. Check whether the related wiring and terminal are abnormal, check whether there are any foreign materials or other environmental abnormalities, and take corresponding corrective measures when necessary.</li> <li>3. If the fault persists, please contact Sungrow Power Customer Service.</li> </ol>
264-283	MPPT Reverse Connection	<ol style="list-style-type: none"> <li>1. Check whether the corresponding string is of reverse polarity. If so, disconnect the DC switch and adjust the polarity when the string current drops below 0.5 A.</li> <li>2. Contact Sungrow Customer Service if the preceding causes are ruled out and the fault persists.</li> </ol> <p>*The code 264 to code 279 are corresponding to string 1 to string 20 respectively.</p>

Fault Code	Fault Name	Corrective Measures
332-363	Boost Capacitor Overvoltage Alarm	<ol style="list-style-type: none"> <li>1. The inverter can continue running.</li> <li>2. Check whether the related wiring and terminals are abnormal, check whether there are any foreign materials or other environmental abnormalities, and take corresponding corrective measures when necessary.</li> </ol> <p>If the fault persists, please contact Sungrow Power Customer Service.</p>
364-395	Boost Capacitor Overvoltage Fault	<ol style="list-style-type: none"> <li>1. Disconnect the AC and DC switches, and disconnect the battery side switches if there are batteries. Close the AC and DC switches in turn 15 minutes later and restart the system.</li> <li>2. If the fault persists, please contact Sungrow Power Customer Service.</li> </ol>
1548-1579	String Current Reflux	<ol style="list-style-type: none"> <li>1. Check whether the number of PV modules of the corresponding string is less than other strings. If so, disconnect the DC switch and adjust the PV module configuration when the string current drops below 0.5 A.</li> <li>2. Check whether the PV module is shaded;</li> <li>3. Disconnect the DC switch to check whether the open circuit voltage is normal when the string current drops below 0.5 A. If so, check the wiring and configuration of the PV module,</li> <li>4. Check whether the orientation of the PV module is abnormal.</li> </ol>



Fault Code	Fault Name	Corrective Measures
1600 - 1615, 1632 - 1655	PV Grounding Fault	<ol style="list-style-type: none"> <li>1. When the fault occurs, it is forbidden to directly disconnect the DC switch and unplug PV terminals when the direct current is greater than 0.5 A;</li> <li>2. Wait until the direct current of the inverter falls below 0.5 A, then disconnect the DC switch and unplug the faulty strings;</li> <li>3. Do not reinsert the faulty strings before the grounding fault is cleared;</li> <li>4. If the fault is not caused by the foregoing reasons and still exists, contact Sungrow Customer Service.</li> </ol>
1616	System Hardware Fault	<ol style="list-style-type: none"> <li>1. It is prohibited to disconnect the DC switch when the DC current is greater than 0.5 A when the fault occurs.</li> <li>2. Disconnect the DC switch only when the inverter DC side current drops below 0.5 A.</li> <li>3. It is prohibited to power up the inverter again. Please contact Sungrow Customer Service.</li> </ol>

Once a fault occurs to the optimizer, the fault information is displayed on the App.

Fault Code	Fault Name	Possible Cause	Corrective Method
4	Input overvoltage	The PV voltage is higher than the set protection value	Check whether the open-circuit voltage of the PV module connected to the optimizer exceeds the maximum input voltage allowed by the optimizer.
512	Hardware fault	A hardware fault occurs to the optimizer	Please contact Sungrow Customer Service.
1024	Update failed	The optimizer software fails to upgrade	<ol style="list-style-type: none"> <li>1. The software upgrade may take more than 20 minutes for a large-scale system with a great number of optimizers. Please check the light condition, and perform the software upgrade under good light conditions.</li> <li>2. If the fault persists, please contact Sungrow Customer Service.</li> </ol>



- If there is a string current backfeed fault, first check whether the optimizer is offline.
- Contact the dealer if the measures listed in the “Troubleshooting Method” column have been taken but the problem persists. Contact SUNGROW if the dealer fails to solve the problem.

## 9.2 Maintenance

### 9.2.1 Maintenance Notices

The DC switch can be secured with a lock in the OFF position or a certain angle beyond the OFF position.(For countries “AU” and “NZ”)

#### DANGER

**Risk of inverter damage or personal injury due to incorrect service!**

- **Be sure to use special insulation tools when perform high-voltage operations.**
- **Before any service work, first disconnect the grid-side AC circuit breaker and check the inverter status. If the inverter indicator is off, please wait until night to disconnect the DC switch. If the inverter indicator is on, directly disconnect the DC switch.**
- **After the inverter is powered off for 10 minutes, measure the voltage and current with professional instrument. Only when there is no voltage nor current can operators who wear protective equipment operate and maintain the inverter**
- **Even if the inverter is shut down, it may still be hot and cause burns. Wear protective gloves before operating the inverter after it cools down.**
- **When maintaining the product, it is strictly prohibited to open the product if there is an odor or smoke or if the product appearance is abnormal. If there is no odor, smoke, or obvious abnormal appearance, repair or restart the inverter according to the alarm corrective measures. Avoid standing directly in front of the inverter during maintenance.**

#### CAUTION

**To prevent misuse or accidents caused by unrelated personnel: Post prominent warning signs or demarcate safety warning areas around the inverter to prevent accidents caused by misuse.**

**NOTICE**

**Restart the inverter only after removing the fault that impairs safety performance. As the inverter contains no component parts that can be maintained, never open the enclosure, or replace any internal components.**

**To avoid the risk of electric shock, do not perform any other maintenance operations beyond those described in this manual. If necessary, contact your distributor first. If the problem persists, contact SUNGROW. Otherwise, the losses caused is not covered by the warranty.**

**NOTICE**

**Touching the PCB or other static sensitive components may cause damage to the device.**

- **Do not touch the circuit board unnecessarily.**
- **Observe the regulations to protect against electrostatic and wear an anti-static wrist strap.**

### 9.2.2 Quick Shutdown

The PV system can perform a quick shutdown, reducing the output voltage of strings to below 30 V within 20 s.

Triggering methods of quick shutdown:

- Method 1: Turn off the AC circuit breaker between the inverter and the grid.
- Method 2: Connect RSD-1 and RSD-2 in COM2 port to trigger quick shutdown. Disconnect RSD-1 and RSD-2 to exit the quick shutdown mode.

**NOTICE**

- **The quick shutdown is not supported if optimizers are configured for some PV modules.**
- **Please check regularly whether the quick shutdown function is normal.**

### 9.2.3 Routine Maintenance

Item	Method	Period
Device clean	Check the temperature and dust of the inverter. Clean the inverter enclosure if necessary.	Six months to a year (depending on the dust contents in air)
Electrical connection	Check whether all cable are firmly connected in place. Check whether there is damage to the cables, especially the surface in contact with metal.	6 months after commissioning and then once or twice a year
General status of the system	<ul style="list-style-type: none"> <li>• Visual check for any damage or deformation of the inverter.</li> <li>• Check any abnormal noise during the operation.</li> <li>• Check each operation parameter.</li> <li>• Be sure that nothing covers the heat sink of the inverter.</li> </ul>	Every 6 months

# 10 Appendix

## 10.1 Technical Data

Parameter	SG2.0RS-S	SG2.5RS-S	SG3.0RS-S
<b>Input (DC)</b>			
Recommended max. PV input power	3.0 kWp	3.75 kWp	4.5 kWp
Max. PV input voltage	600 V <sup>(1)</sup>		
Min. operating PV voltage / Start-up input voltage	40 V / 50 V		
Nominal input voltage	360 V		
MPP voltage range	40 V – 560 V		
MPP voltage range for rated power	190~480V	235~480V	280~480V
No. of MPPTs	1		
Default No. of PV strings per MPPT	1		
Max. PV input current	16 A		
Max. DC short-circuit current	20 A		
<b>Output (AC)</b>			
Rated AC output power	2000 W	2500 W	3000 W
Max. AC output apparent power	2000 VA	2500 VA	3000 VA
Rated AC output apparent power	2000 VA	/	/
Rated AC output current (at 230 V)	8.7 A	10.9 A	13.1 A
Max. AC output current	9.1 A	11.4 A	13.7 A
Rated AC voltage	220 V / 230 V / 240 V		
AC voltage range	154 V – 276 V		
Rated grid frequency / Grid frequency range	50 Hz / 45 Hz – 55 Hz, 60 Hz / 55 Hz – 65 Hz		
Harmonic (THD)	< 3 % (at rated power)		
Power factor at rated power / Adjustable power factor	> 0.99 / 0.8 leading - 0.8 lagging		

Parameter	SG2.0RS-S	SG2.5RS-S	SG3.0RS-S
Feed-in phases / connection phases	1 / 1		
<b>Efficiency</b>			
Max. efficiency / European efficiency	97.8 % / 96.9 %	97.8 % / 97.2 %	97.8 % / 97.3 %
<b>Protection</b>			
Grid monitoring	Yes		
DC reverse polarity protection	Yes		
AC short circuit protection	Yes		
Leakage current protection	Yes		
Surge Protection	DC type II / AC type II		
DC switch	Yes	Yes	Yes
PV string current monitoring	Yes		
Arc fault circuit interrupter (AFCI)	Optional		
PID Zero	Yes		
Protective Class	I		
Overvoltage Category	DC II/AC III		
Active Anti-Islanding Method	Frequency Shift		
<b>General Data</b>			
Dimensions (W x H x D)	320 mm x 225 mm x 120 mm		
Weight	6 kg		
Mounting method	Wall-mounting bracket		
Topology	Transformerless		
Degree of protection	IP65		
Operating ambient temperature range	-25°C to +60°C		
Allowable relative humidity range (non-condensing)	0–100 %		
Max. operating altitude	4000 m		
Cooling method	Natural cooling		
Display	LED digital display & LED indicator		
Communication	Ethernet / WLAN / RS485 / DI (Ripple control & DRM)		
DC connection type	MC4 (Max. 6 mm <sup>2</sup> )/MC4 Compatible Connector (Max. 6 mm <sup>2</sup> )		

Parameter	SG2.0RS-S	SG2.5RS-S	SG3.0RS-S
AC connection type	Plug and play connector (Max. 6 mm <sup>2</sup> )		
Grid support	Active & reactive power control and power ramp rate control		

(1) The inverter enters standby state when the input voltage ranges between 560 V and 600 V.

Parameter	SG3.0RS	SG3.6RS	SG4.0RS
<b>Input (DC)</b>			
Recommended max. PV input power	4.5 kWp	5.4 kWp	6 kWp
Max. PV input voltage	600 V <sup>(1)</sup>		
Min. operating PV voltage / Start-up input voltage	40 V / 50 V		
Rated PV input voltage	360 V		
MPP voltage range	40 V – 560 V		
MPP voltage range for rated power	140~480V	170~480V	190~480V
No. of MPPTs	2		
Default No. of PV strings per MPPT	1		
Max. PV input current	32 A (16 A / 16 A)		
Max. DC short-circuit current	40 A (20 A / 20 A)		
<b>Output (AC)</b>			
Rated AC output power	3000 W	3680 W <sup>(2)</sup>	4000 W
Max. AC output apparent power	3000 VA	3680 VA <sup>(3)</sup>	4000 VA
Rated AC output apparent power	3000 VA	/	/
Rated AC output current (at 230 V)	13.1 A	16 A	17.4 A
Max. AC output current	13.7 A	16 A	18.2 A
Rated AC voltage	220 V / 230 V / 240 V		
AC voltage range	154 V – 276 V		
Rated grid frequency / Grid frequency range	50 Hz / 45 Hz – 55 Hz, 60 Hz / 55 Hz – 65 Hz		
Harmonic (THD)	< 3 % (at rated power)		

Parameter	SG3.0RS	SG3.6RS	SG4.0RS
Power factor at rated power / Adjustable power factor	> 0.99 / 0.8 leading - 0.8 lagging		
Feed-in phases / connection phases	1 / 1		
<b>Efficiency</b>			
Max. efficiency / European efficiency	97.9 % / 97.0 %	97.9 % / 97.0 %	97.9 % / 97.2 %
<b>Protection</b>			
Grid monitoring	Yes		
DC reverse polarity protection	Yes		
AC short circuit protection	Yes		
Leakage current protection	Yes		
Surge Protection	DC type II / AC type II		
DC switch	Yes	Yes	Yes
PV string current monitoring	Yes		
Arc fault circuit interrupter (AFCI)	Optional		
PID Zero	Yes		
Protective Class	I		
Overtoltage Category	DC II/AC III		
Active Anti-Islanding Method	Frequency Shift		
<b>General Data</b>			
Dimensions (W x H x D)	410 mm x 270 mm x 150 mm		
Weight	10 kg		
Mounting method	Wall-mounting bracket		
Topology	Transformerless		
Degree of protection	IP65		
Operating ambient temperature range	-25°C to + 60°C		
Allowable relative humidity range (non-condensing)	0–100 %		
Max. operating altitude	4000 m		
Cooling method	Natural cooling		
Display	LED digital display & LED indicator		
Communication	Ethernet / WLAN / RS485 / DI (Ripple control & DRM)		



Parameter	SG3.0RS	SG3.6RS	SG4.0RS
DC connection type	MC4 (Max. 6 mm <sup>2</sup> )/MC4 Compatible Connector (Max. 6 mm <sup>2</sup> )		
AC connection type	Plug and play connector (Max. 6 mm <sup>2</sup> )		
Grid support	Active & reactive power control and power ramp rate control		

(1) The inverter enters standby state when the input voltage ranges between 560 V and 600 V.

(2) 3600W for Jordanian utility.

(3) 3600VA for Jordanian utility with max. output current of inverter 16A.

Parameter	SG5.0RS	SG6.0RS
<b>Input (DC)</b>		
Recommended max. PV input power	7.5 kWp	9 kWp
Max. PV input voltage	600 V <sup>(1)</sup>	
Min. operating PV voltage / Start-up input voltage	40 V / 50 V	
Rated PV input voltage	360 V	
MPP voltage range	40 V – 560 V	
MPP voltage range for rated power	235~480V	285~480V
No. of MPPTs	2	
Default No. of PV strings per MPPT	1	
Max. PV input current	32 A (16 A / 16 A)	
Max. DC short-circuit current	40 A (20 A / 20 A)	
<b>Output (AC)</b>		
Rated AC output power	4999 W for "AU", 5000 W for others	6000 W
Max. AC output apparent power	4999 VA for "AU", 5000 VA for others	6000 VA
Max. AC output apparent power	4999 VA for "AU", 5000 VA for others	/
Rated AC output current (at 230 V)	21.7 A for "AU", 21.8 A for others	26.1 A
Max. AC output current	21.7 A for "AU", 22.8 A for others	27.3 A
Rated AC voltage	220 V / 230 V / 240 V	
AC voltage range	154 V – 276 V	

Parameter	SG5.0RS	SG6.0RS
Rated grid frequency / Grid frequency range	50 Hz / 45 Hz – 55 Hz, 60 Hz / 55 Hz – 65 Hz	
Harmonic (THD)	< 3 % (at rated power)	
Power factor at rated power / Adjustable power factor	> 0.99 / 0.8 leading - 0.8 lagging	
Feed-in phases / connection phases	1 / 1	
<b>Efficiency</b>		
Max. efficiency / European efficiency	97.9 % / 97.3 %	97.9 % / 97.5 %
<b>Protection</b>		
Grid monitoring	Yes	
DC reverse polarity protection	Yes	
AC short circuit protection	Yes	
Leakage current protection	Yes	
Surge Protection	DC type II / AC type II	
DC switch	Yes	Yes
PV string current monitoring	Yes	
Arc fault circuit interrupter (AFCI)	Optional	
PID Zero	Yes	
Protective Class	I	
Overvoltage Category	DC II/AC III	
Active Anti-Islanding Method	Frequency Shift	
<b>General Data</b>		
Dimensions (W x H x D)	410 mm x 270 mm x 150 mm	
Weight	10 kg	
Mounting method	Wall-mounting bracket	
Topology	Transformerless	
Degree of protection	IP65	
Operating ambient temperature range	-25°C to +60°C	
Allowable relative humidity range (non-condensing)	0–100 %	
Max. operating altitude	4000 m	
Cooling method	Natural cooling	
Display	LED digital display & LED indicator	
Communication	Ethernet / WLAN / RS485 / DI (Ripple control & DRM)	

Parameter	SG5.0RS	SG6.0RS
DC connection type	MC4 (Max. 6 mm <sup>2</sup> )/MC4 Compatible Connector (Max. 6 mm <sup>2</sup> )	
AC connection type	Plug and play connector (Max. 6 mm <sup>2</sup> )	
Grid support	Active & reactive power control and power ramp rate control	

(1) The inverter enters standby state when the input voltage ranges between 560 V and 600 V.

## 10.2 Quality Assurance

When product faults occur during the warranty period, SUNGROW will provide free service or replace the product with a new one.

### Evidence

During the warranty period, the customer shall provide the product purchase invoice and date. In addition, the trademark on the product shall be undamaged and legible. Otherwise, SUNGROW has the right to refuse to honor the quality guarantee.

### Conditions

- After replacement, unqualified products shall be processed by SUNGROW.
- The customer shall give SUNGROW a reasonable period to repair the faulty device.

### Exclusion of Liability

In the following circumstances, SUNGROW has the right to refuse to honor the quality guarantee:

- The free warranty period for the whole machine/components has expired.
- The device is damaged during transport.
- The device is incorrectly installed, refitted, or used.
- The device operates in harsh conditions beyond those described in this manual.
- The fault or damage is caused by installation, repairs, modification, or disassembly performed by a service provider or personnel not from SUNGROW.
- The fault or damage is caused by the use of non-standard or non-SUNGROW components or software.
- The installation and use range are beyond stipulations of relevant international standards.
- The damage is caused by unexpected natural factors.

For faulty products in any of above cases, if the customer requests maintenance, paid maintenance service may be provided based on the judgment of SUNGROW.

## 10.3 Contact Information

In case of questions about this product, please contact us.

We need the following information to provide you the best assistance:

- Model of the device
- Serial number of the device
- Fault code/name
- Brief description of the problem

For detailed contact information, please visit: <https://en.sungrowpower.com/contactUS>

**SUNGROW**

Sungrow Power Supply Co., Ltd.  
[www.sungrowpower.com](http://www.sungrowpower.com)