

Quick Installation Guide

SG30CX/SG50CX

PV Grid-connected Inverter

SG30_50CX-V14-QIEN-Ver13-202202 Version: 1.3



This guide is valid for inverters SG30CX, SG50CX, providing the installation, electrical connection, commissioning and troubleshooting procedure.

⚠ NOTICE

- Contents may be periodically updated or revised due to product development, The information in this guide is subject to change without notice. In no case shall this guide substitute for the user manual or related notes on the device.
- Make sure to read over, fully understand and strictly follow the detailed instructions of the user manual and other related regulations before installing the equipment. The user manual can be downloaded by visiting the website at <http://support.sungrowpower.com/>; or it can be obtained by scanning the QR code on the side of the equipment or the back cover of this guide.
- All operations can be performed only by qualified personnel, that must be trained in the installation and commissioning of the electrical system, as well as the dealing with hazards, have knowledge of the manual and of the local regulations and directives.
- Before installation, check that the package contents are intact and complete against the packing list. Contact SUNGROW or the distributor in case of any damaged or missing components.
- The cable must be intact and well insulated. Operation personnel must wear proper personal protective equipment (PPE) all the time.

1 Product Introduction

1-1 Appearance

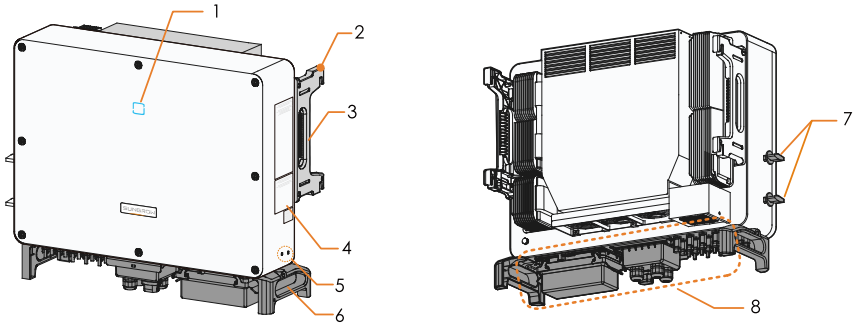

1. LED indicator 2. Mounting ear 3. Side handles 4. Warning symbols, nameplate, and QR code
 5. Additional grounding terminals 6. Bottom handles 7. DC switches 8. Wiring area

1-2 Dimensions

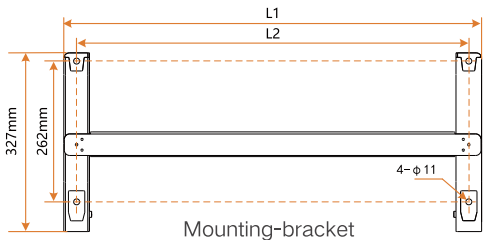
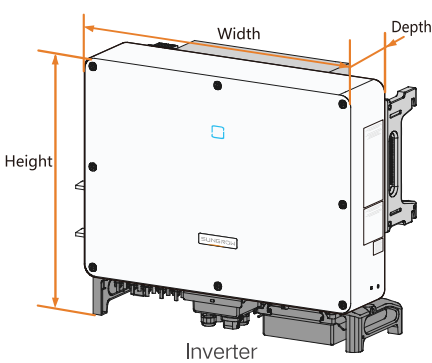

Type	(WxHxD)	Weight	L1	L2
SG30CX	702x595x310 (mm)	50kg	687mm	640mm
SG50CX	782x645x310 (mm)	62kg	767mm	720mm

*The image shown here is for reference only. The actual product you receive may differ.

2 Mechanical Mounting

2-1 Location Selection

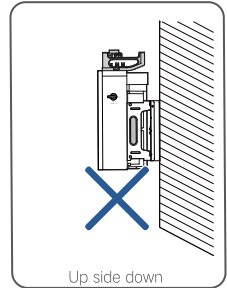
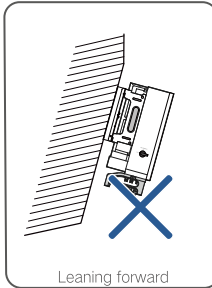
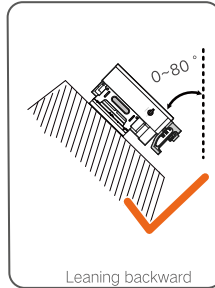
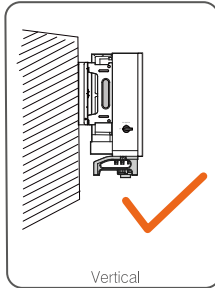
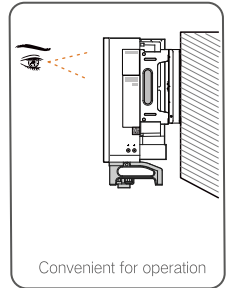
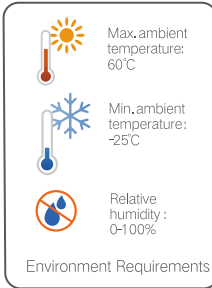
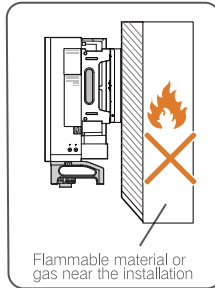
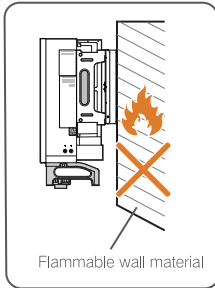

Please consult SUNGROW before tilting backwards the inverter and install it in floating power plants.

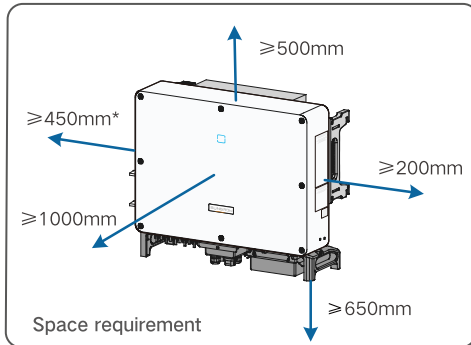

i * In case the distance is less than 450mm, move the inverter from the mounting-bracket or wall before maintaining fans.

2-2 Installation

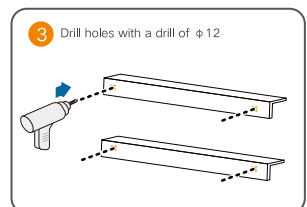
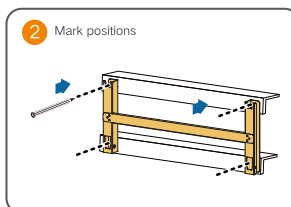
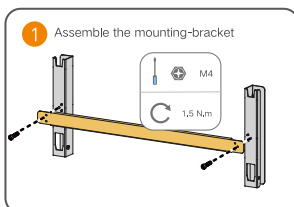

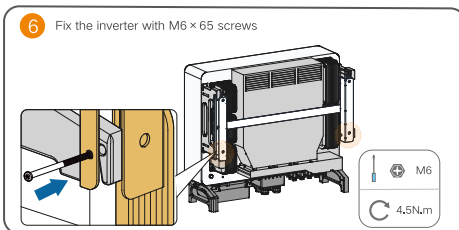
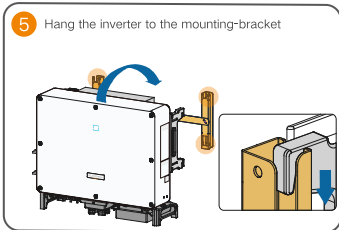
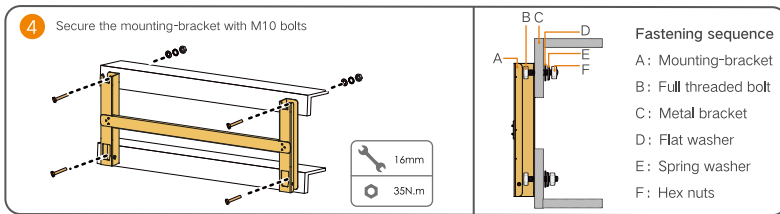

3 Electrical Connection

Overview

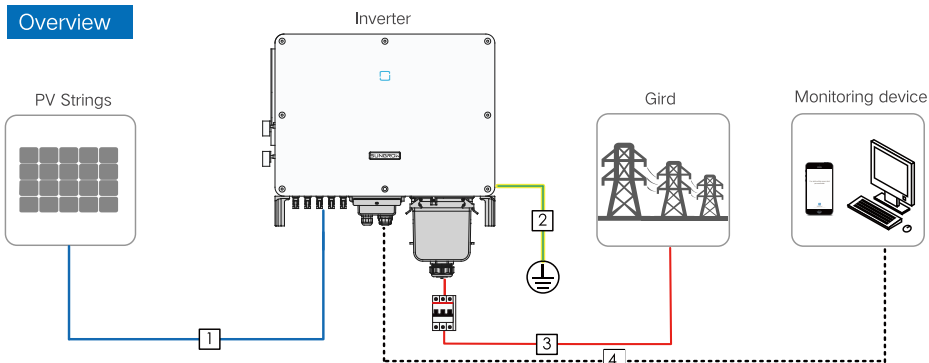

3-1 Cable requirements

No	Cable	Type	Outer diameter(mm)	Cross section(mm ²)
1	DC cable	PV cable complying with 1,500V standard	6-9	4-6
2	Additional grounding cable	Outdoor single-core copper wire cable	The same as that of the PE wire in the AC cable	
3	AC cable	Outdoor multi-core copper or aluminium cable	20-50	L1,L2,L3,N (SG30CX): 16-70 L1,L2,L3,N (SG50CX): 35-70 PE wire: Depends on phase wire cross-section S, When 16 < S ≤ 35, it is 16, When S > 35, it is S/2.
4	Communication cable	Shielded twisted pair (terminal block) CAT-5 Ethernet cable (RJ45)	4,5-18	1-1,5 /

⚠ NOTICE

- The DC cable must be a multi-core cables.

3-2 Additional Grounding Connection

⚠ NOTICE

- Since the inverter is a transformerless inverter, neither the negative pole nor the positive pole of the PV string can be grounded. Otherwise, the inverter will not operate normally.
- There are two terminals. Use at least one of them to ground the inverter.
- Apply paint to the grounding terminal to ensure corrosion resistance after connection.

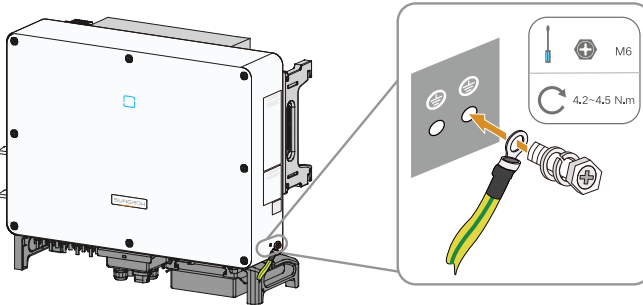

3-3 AC Connection

⚠ NOTICE

- Before connecting the inverter to the grid, ensure the grid voltage and frequency comply with requirements.
- Disconnect the AC-side circuit breaker and prevent it from inadvertent reconnection.
- Observe the pin assignment of AC terminal block. If a phase wire is connected to the "PE" terminal, it may permanently damage the inverter.
- Please avoid squeezing the cable insulation layer into the AC terminal. Improper connection may affect the normal operation of the inverter.
- During AC cable connection, the cables inside the lower part of the device should be bended to be surplus in length. In this way, cable drooping or loosening, which can cause arc or other problems impairing functionality of the device, due to self-weight of the cables in case of land subsidence is avoided.
- If an aluminium cable is selected, use a copper to aluminium adapter terminal to avoid direct contact between the copper bar and the aluminium cable. See user manual for more details.

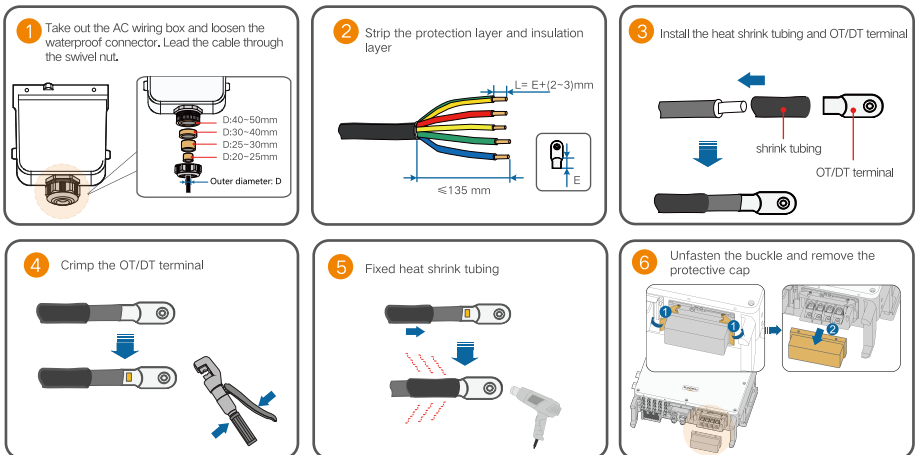

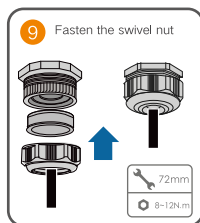
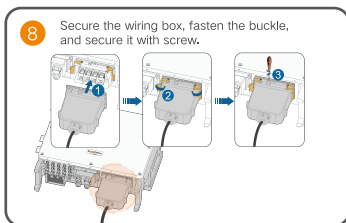
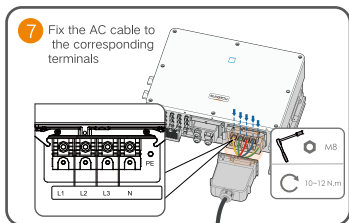

3-4 DC connection

⚠ NOTICE

- Use the MC4 DC terminal within the scope of delivery. Damage to the device due to the use of incompatible terminal shall not be covered by the warranty.
- There is a risk of inverter damage! The following requirements should be met. Failure to do so will void guarantee and warranty claims.
 - Ensure that the open circuit voltage in any case does not exceed the inverter input upper limit of 1100V.
 - Make sure the maximum short circuit current on the DC side is within the permissible range.
 - Make sure the to-ground insulation performance of the PV string is sound.
- The inverter will not function properly if the DC polarities are reversed.
- If the PV connectors are not assembled into place, it may cause an arc or overheat. The loss caused by this issue will void the warranty.

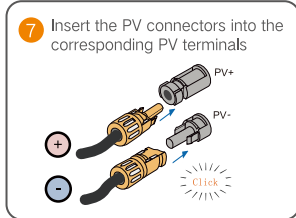
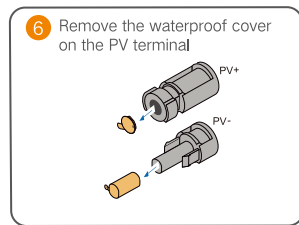
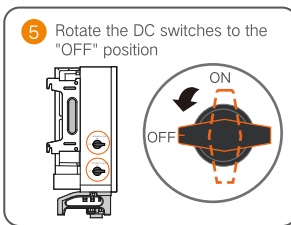
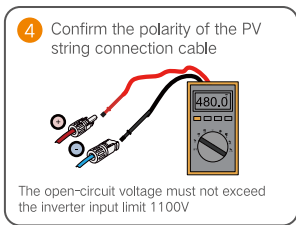
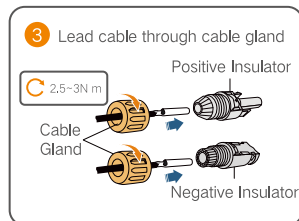
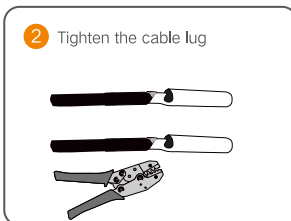
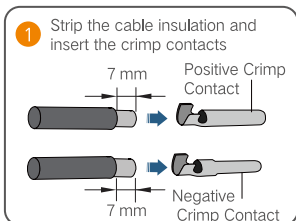

3-5 RS485 Communication Connection

As shown in the figure below, the inverter is equipped with three RS485 communication interfaces and one dip switch.

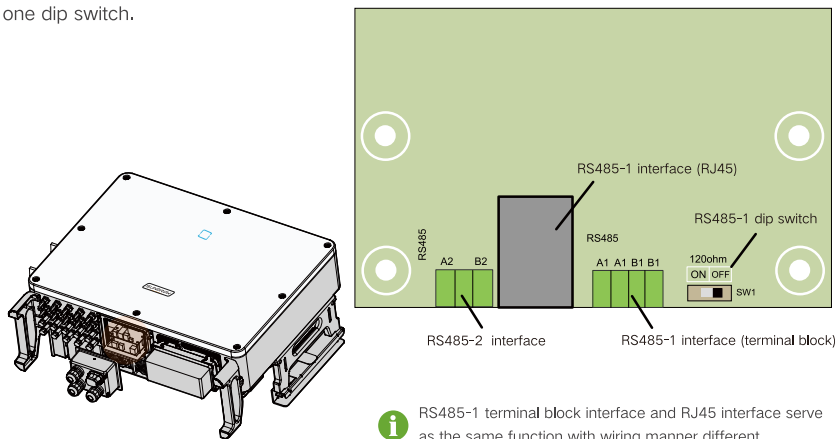

All the three interfaces can be connected to a data acquisition device (Logger), to achieve data exchange with PC or other monitoring devices. Multiple inverters can be connected in the daisy chain manner via the RS485-1 terminal block and RJ45 terminal. A 120Ω resistor can be connected in parallel between RS485-1 A/B pins by configuring the dip switch.

3-5-1 Communication junction box

Removal

Pull out the pin, and remove the junction box.

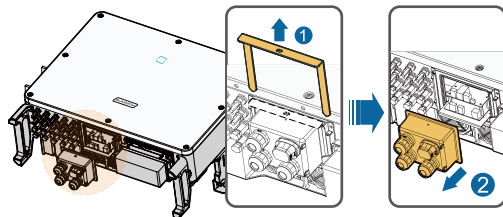

i The pin removed is a required accessory for fixing the junction box. Store it properly and protect it against missing or deformation.

Installation

Remount the junction box and press it tightly, insert the pin, and secure the junction box with the supplied M4 × 25 screw.

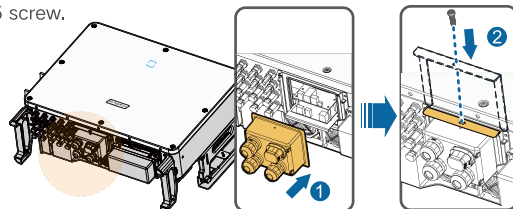

i

- During installation, press the junction box forcibly to ensure that the pin can be inserted successfully.
- Never hit the pin with a heavy object, such as hammer. Otherwise, it will be irrecoverably

3-5-2 Connection Procedure

Terminal Block

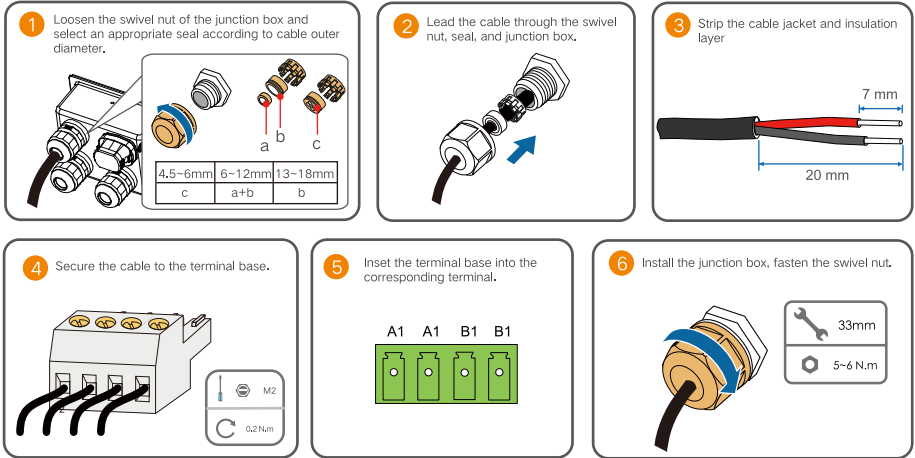

*The image shown here is for reference only. Please wire according to the actual terminal definition.

RJ45

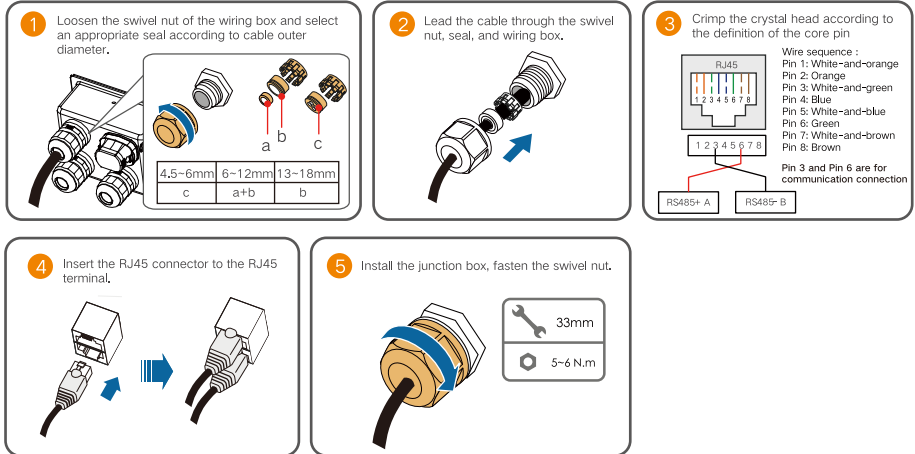

⚠ NOTICE

- There are three RS485 communication terminals, and the silk screen marks are COM1/COM3/COM4. Please choose according to the actual situation.

4 Commission

4-1 Inspection before Commissioning

No.	Items	Result	
		Yes	No
1	All equipment has been reliably installed.	<input type="checkbox"/>	<input type="checkbox"/>
2	DC and AC switches are in the "OFF" position.	<input type="checkbox"/>	<input type="checkbox"/>
3	The ground cable is properly and reliably connected.	<input type="checkbox"/>	<input type="checkbox"/>
4	The AC cable is properly and reliably connected.	<input type="checkbox"/>	<input type="checkbox"/>
5	The DC cable is properly and reliably connected.	<input type="checkbox"/>	<input type="checkbox"/>
6	The communication cable is properly and reliably connected.	<input type="checkbox"/>	<input type="checkbox"/>
7	The vacant terminals are sealed.	<input type="checkbox"/>	<input type="checkbox"/>
8	No foreign items, such as tools, are left on the top of the machine or in the junction box (if there is).	<input type="checkbox"/>	<input type="checkbox"/>
9	The AC circuit breaker is selected in accordance with the requirements of this manual and local standards.	<input type="checkbox"/>	<input type="checkbox"/>
10	All warning signs & labels are intact and legible.	<input type="checkbox"/>	<input type="checkbox"/>

4-2 Commissioning Procedure

Step1 Connect the AC switch between the inverter and the grid.

Step2 Rotate the DC switch to the "ON" position.

*Skip performing step1 when the actual device is not equipped with DC switches.

Step3 Connect the DC switch (if applicable) between the inverter and the PV string.

Step4 Set initial protection parameters via the iSolarCloud APP. If the irradiation and grid conditions meet requirements, the inverter will normally operate.

Step5 Observe the LED indicator to ensure that the inverter operates normally.

LED indicator description

	Steady blue	The device is connected to the grid and operating normally.
	Periodical flashing blue (Period: 0.2s)	The Bluetooth communication is connected and there is data communication, No inverter fault occurs.
	Periodical flashing blue (Period: 2s)	The DC or AC side is powered on and the device is in standby or startup state (not feeding power into the grid).
	Steady red	A fault occurs and the device cannot connect to the grid.
	Flashing red	The Bluetooth communication is connected and there is data communication, Fault occurs.
	OFF	Both the AC and DC sides are powered down.

5 iSolarCloud

5-1 Brief Introduction

The iSolarCloud APP can establish communication connection to the inverter via the Bluetooth, thereby achieving near-end maintenance on the inverter. Users can use the APP to view basic information, alarms, and events, set parameters, or download logs, etc.

*In case the communication module Eye, WiFi or WiNet-S is available, the iSolarCloud APP can also establish communication connection to the inverter via the mobile data or WiFi, thereby achieving remote maintenance on the inverter.

5-2 Download and Install

Method 1 : Scan the right QR code to download and install the APP.

Method 2 : Download the APP through the following application stores:

- MyApp (Android, mainland China users)
- Google Play (Android, users other than mainland China ones)
- APP store (iOS)



5-3 Initialize protection parameter

NOTICE

- To log in to the app, the following conditions must be met:
 - (1) The AC and DC sides or the AC side of the inverter is powered-on.
 - (2) The mobile phone is within 5m away from the inverter and there are no obstructions in between.
 - (3) The Bluetooth function of the mobile phone is enabled.

Step1 After the installation is complete, click "Open" or click the phone desktop APP icon to open the app.



Step2 Scan the QR code on the side of the inverter for Bluetooth connection. Or tap MANUAL CONNECTION at the bottom of the interface and select Others, the Bluetooth search interface will automatically appear. Select the inverter to be connected according to the serial number on the nameplate on the side of the inverter, or tap  to scan the QR code on the side of the inverter for Bluetooth connection. The connection is successfully established if the LED indicator blinks blue.

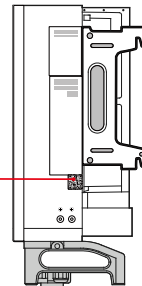
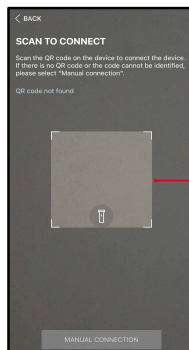
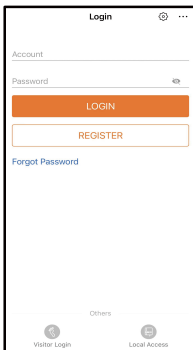

Step3 Enter the identity verification screen after the Bluetooth connection is established.

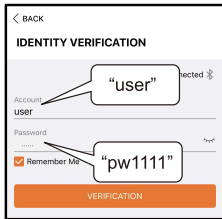

Step4 After finishing the settings, tap TUNR ON DEVICE at the upper right corner and the device will be initialized. The App will send start instructions and the device will start and operate.

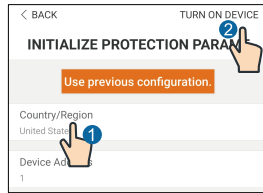

NOTICE

- The user name is "user" and the initial password is "pw1111" or "111111". To ensure account security, please change the password as soon as possible.
- Reset the protection parameters if the country setting is incorrect. Otherwise, fault may occur.
- In the European region, such as Sweden, Norway, Hungary, Portugal, Romania, Greece, Ukraine etc. whose grid code complies with EN50549, select the parameter EN50549_1 (LV grid-connection) or EN50549_2 (MV grid-connection) with proper manual settings.
- In the Brazilian region, set the country code to "Brazil". Selecting "Brazil_230" or "Brazil_240" will cause setting failure.
- For SG30CX, set the grid code as EN50549 in the Ukraine region and apply manual settings for country code compliance.

Step5 If the inverter is initialized, the APP automatically turns to its home page.



Home page

*Screenshots in this manual are based on the Android system V2.1.6, and the actual interfaces may differ.



More information in the QR code or at <http://support.sungrowpower.com/>

SUNGROW

Specifications are subject to changes without advance notice.

