

# Agave-SH Single Phase Hybrid AIO BESS User Manual

WH-SPHA 3.6H-10.24kWh  
WH-SPHA 5.0H-10.24kWh  
WH-SPHA 6.0H-10.24kWh

WH-SPHA 3.6H-5.12kWh  
WH-SPHA 5.0H-5.12kWh  
WH-SPHA 6.0H-5.12kWh



## CONTENTS

<b>1. General Introduction.....</b>	<b>5</b>
1.1. System Introduction.....	5
1.2. Safety Introduction.....	5
1.2.1. Warning and Safety Symbols .....	5
1.3. Packing List .....	7
1.4. System Overview .....	13
1.5. Limitation of Liability.....	15
<b>2. Installation .....</b>	<b>17</b>
2.1. Installation Location and Environment.....	17
2.1.1. General.....	17
2.1.2. Location Restrictions .....	18
2.1.3. Barriers to Habitable Rooms .....	18
2.1.4. Choosing an Installation Location.....	19
2.2. Installation Steps.....	20
2.2.1. Battery Box Installation.....	20
2.2.2. Inverter Box Installation.....	25
2.3. Cable Connections.....	26
2.3.1. General.....	26
2.3.2. Connect the Inverter Box and Battery Box .....	27
2.3.3. System Wiring Diagram .....	33
2.3.4. Power Meter.....	35
2.4. DRED Connection .....	35
<b>3. System Operation.....</b>	<b>38</b>
3.1. Turning on the BESS.....	38
3.2. Turning off the BESS.....	39
3.3. Emergencies.....	40
3.3.1. Emergency Procedures.....	40
3.3.2. First Aid Procedures .....	40
3.3.3. Firefighting Measures .....	40
<b>4. ECACTUS CONFIGURATION &amp; WI-FI RELOAD .....</b>	<b>42</b>
4.1. Preparations.....	42
4.2. Wi-Fi Reset & Restore .....	43
4.3. Change Password & Delete Account.....	45
4.4. Installing the Side Panels.....	47
<b>5. EMS Configurations.....</b>	<b>48</b>
<b>6. Troubleshooting .....</b>	<b>49</b>
<b>7. Cleaning And Maintenance .....</b>	<b>53</b>
7.1. Warranty.....	53
7.2. Cleaning.....	53

7.3. Storage and Maintenance .....	53
<b>8. Annex .....</b>	<b>55</b>
8.1. Datasheet.....	55
<b>9. Labels .....</b>	<b>58</b>
9.1. Inverter Label.....	58
9.2. Battery Label.....	59

## Copyright Statement

JIANGSU WEIHENG INTELLIGENT TECHNOLOGY CO., LTD (hereinafter referred to as eCactus, eCactus is the sub-brand of WEIHENG focusing on providing household energy storage solutions) owns the copyright to this manual. All rights reserved. Please properly store the manual and strictly follow all safety and operating instructions provided. Please do not operate the system before reading through this manual.

## Version Information

Version	Date	Content
V1.0	2023-5-5	
V1.1	2023-12-6	Added the expression for installation clearance

# 1. General Introduction

## 1.1. System Introduction









The WH-SPHA series hybrid all-in-one battery energy storage system (BESS) is designed for both indoor and outdoor use. The BESS can store DC power generated by PV arrays in the battery or convert it into AC to power AC loads. This user manual applies to the following products:

WH-SPHA3.6H-5.12kWh/WH-SPHA3.6H-10.24kWh,  
 WH-SPHA5.0H-5.12kWh/WH-SPHA5.0H-10.24kWh,  
 WH-SPHA6.0H-5.12kWh/WH-SPHA6.0H-10.24kWh.

## 1.2. Safety Introduction

### 1.2.1. Warning and Safety Symbols

● **SYMBOLS EXPLANATION**

	Caution! Failing to observe warnings indicated in this manual may result in injury.
	High voltage and electric shock hazard.
	Hot surface.
	Recyclable product components.
	This side up. The package must always be transported, handled, and stored upright, with the arrows pointing upwards.
	Do not stack more than five (5) identical packages on top of each other.
	Do not dispose of the product as household waste.
	Handle the package/product with care, and do not tip it over or throw it.
	Refer to the operating instructions.



Keep dry! The package/product must be protected from excessive humidity and stored covered.



Wait at least 5 minutes after turning off the inverter before touching or using it to prevent electrical shocks or injuries.



CE Mark.



This mark indicates compound UK product safety certification requirements.

## ● SAFETY WARNING

The BESS must only be installed or operated by qualified electricians in compliance with local grid authority or company standards, wiring rules, and requirements (such as AS 4777 and AS/NZS 3000 in Australia).

Disconnect all batteries and AC power sources from the BESS for at least 5 minutes before connecting any wires or conducting any electrical work to ensure the BESS is completely isolated and to avoid electric shocks.

The surface of the BESS may exceed temperatures of 60°C during operation. Please make sure it has cooled down before touching it, and make sure that the BESS is out of the reach of children.

The BESS must be used and operated as described in this user manual, or safety features may not work as intended, and the warranty for the BESS will be voided.

Your BESS warranty will be voided if you open the BESS cover or change any component without eCactus's authorization.

Care must be taken to protect the BESS from static damage. The WEIHENG Limited Warranty does not cover any damage caused by static.

Neutral continuity is NOT maintained internally and must be achieved through external connections, as shown in the system connection diagram for Australia on page 33 section 2.3.3.









This BESS features a built-in residual current monitoring unit (RCMU). Only use type B external residual current device (RCD) rated for a tripping current of 30 mA or higher.

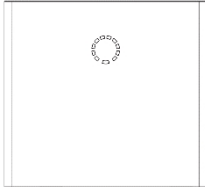
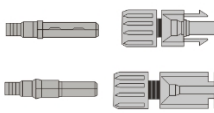
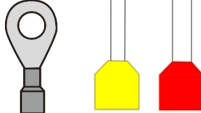

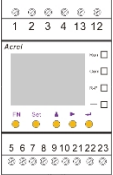
This BESS features active anti-islanding protection, and inverter frequency is shifted away from nominal conditions in the absence of a reference frequency (frequency shift).

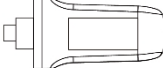
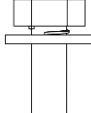
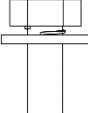

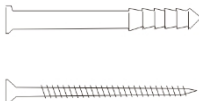

This BESS is a multimode inverter designed to be used in unconditioned outdoor shaded environments. The maximum operating ambient temperature is 55°C.

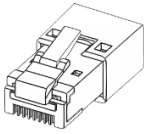
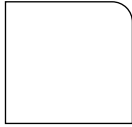
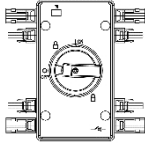
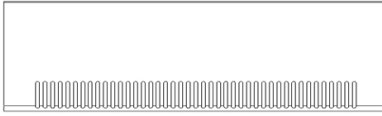
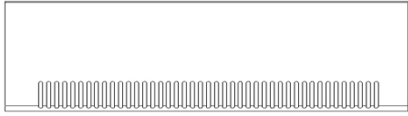
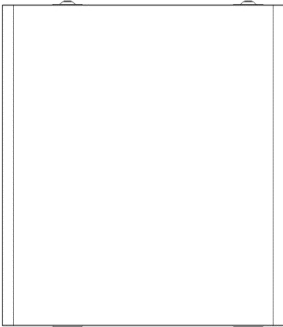
An error message will be sent to the ECOS app in the event of a ground fault, and the status indicator on the product will turn red.



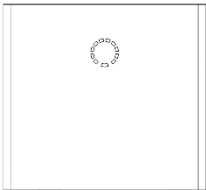

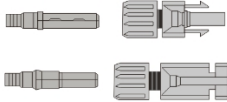
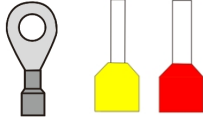

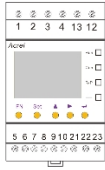

### 1.3. Packing List

WH-SPHA-3.6H/5.0H/6.0H-5.12kWh with Single Phase Meter				
				
1×Inverter	2×Positive DC Connectors 2×Negative DC Connectors	1×OT5-4 terminal 3×E10-12 3×E6012	2× Upper and Lower Connection Panels	
				
1×Single Phase Meter	1× Quick Installation Guide	1× Wi-Fi Module	8× M4*10	1× M4*10 (PE)
				
1× Back Panel	4× Pads	10× Cable Ties	2×Expansion Pipes	

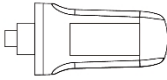
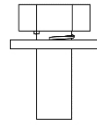
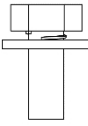
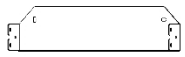
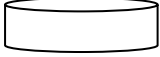

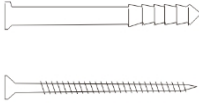
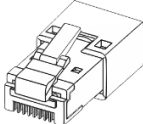
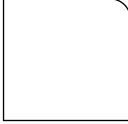
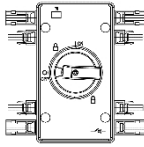

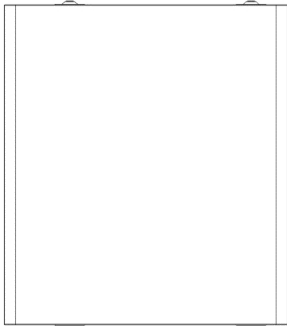





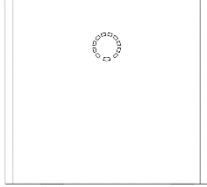
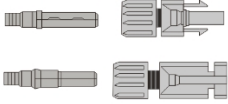
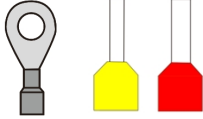

		
1×RJ45 Connector	Label Accessories	1×PV Switch
		
1× Left Side Panel	1× Right Side Panel	
<b>WH-BXB5.12</b>		
		
1× Battery Box		
		
1× Battery Box Left Side Panel	1× Battery Box Right Side Panel	

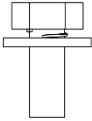
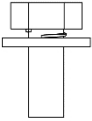

<b>WH-SPHA-3.6H/5.0H/6.0H-10.24kWh with Single Phase Meter</b>				
				
1×Inverter	2× Cables	2×Positive DC Connectors 2×Negative DC	1×OT5-4 terminal 3×E10-12	4× Upper and Lower Connection

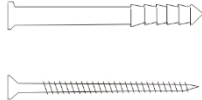
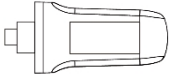

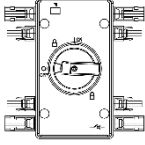



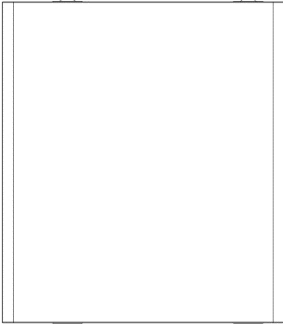

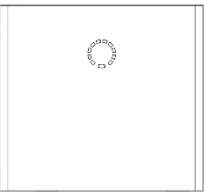
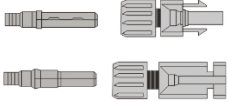
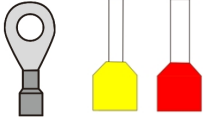

		Connectors	3×E6012	Panels
				
1×Single Phase Meter	1× Quick Installation Guide	1× Wi-Fi Module	16× M4*10	1× M4*10 (PE)
				
2× Back Panels	4× Pads	15× Cable Ties	4×Expansion Pipes	
				
1×RJ45 Connector	Label Accessories	1×PV Switch		
				
1× Left Side Panel	1× Right Side Panel			
<b>2× WH-BXB5.12</b>				
				
<b>2× Battery Box</b>				
				

2× Battery Box Left Side Panel	2× Battery Box Right Side Panel
--------------------------------	---------------------------------

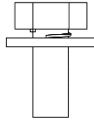
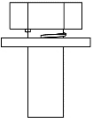
WH-SPHA-3.6H/5.0H/6.0H-5.12kWh with Three Phase Meter			
			
1× Inverter	2× Positive DC Connectors 2× Negative DC Connectors	1× OT5-4 terminal 3× E10-12 3× E6012	2× Upper and Lower Connection Panels
			
1× Three Phase Meter	1× Quick Installation Guide	8× M4*10	1× M4*10 (PE)
			
1× Back Panel	4× Pads	10× Cable Ties	2× Expansion Pipes
			
1× Wi-Fi Module	Label Accessories	1× PV Switch	
			
1× Left Side Panel	1× Right Side Panel		

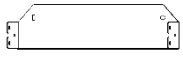
<b>WH-BXB5.12</b>	
	
<b>1× Battery Box</b>	
	
<b>1× Battery Box Left Side Panel</b>	<b>1× Battery Box Left Side Panel</b>

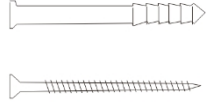
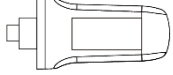
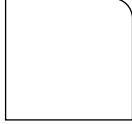
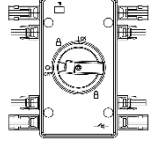
<b>WH-SPHA-3.6H/5.0H/6.0H-10.24kWh with Three Phase Meter</b>				
				
<b>1×Inverter</b>	<b>2×Positive DC Connectors 2×Negative DC Connectors</b>	<b>1×OT5-4 terminal 3×E10-12 3×E6012</b>	<b>4× Upper and Lower Connection Panels</b>	
				
<b>1×Three Phase Meter</b>	<b>1× Quick Installation Guide</b>	<b>2× Cables</b>	<b>16× M4*10</b>	<b>1× M4*10 (PE)</b>

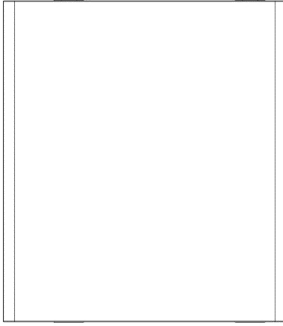
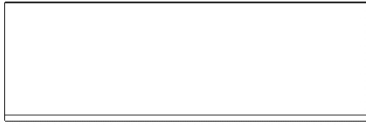
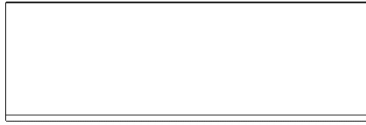
			
2× Back Panels	4× Pads	15× Cable Ties	4×Expansion Pipes
			
1× Wi-Fi Module	Label Accessories	1×PV Switch	
			
1× Left Side Panel	1× Right Side Panel		
<b>2× WH-BXB5.12</b>			
			
2× Battery Box			
			
2× Battery Box Left Side Panel	2× Battery Box Right Side Panel		

### 1.4. System Overview

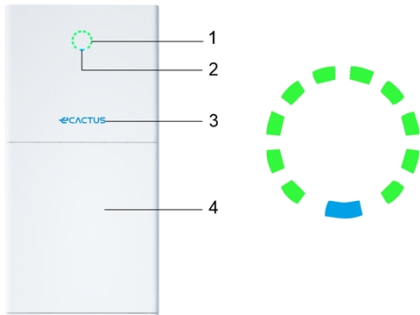

Item	Description
1	Charge indicator
2	Status indicator
3	Logo
4	Battery box *1

Note: \*1 Two battery boxes can be fitted

#### LED INDICATOR:

STATUS	LED INDICATOR	
Standby		Flashing blue LED, 2-second intervals
Checking		Flashing blue LED, 0.5-second intervals
Normal		Solid blue LED
DSP fault		Solid red LED
Battery com. fault		Flashing red LED, 2-second intervals
Meter com. fault		Flashing red LED, 0.5-second intervals
Charge indicator		

The Status indicator will be solid blue when everything is ready, and the Charge indicator indicates battery power.

**BESS connections:**

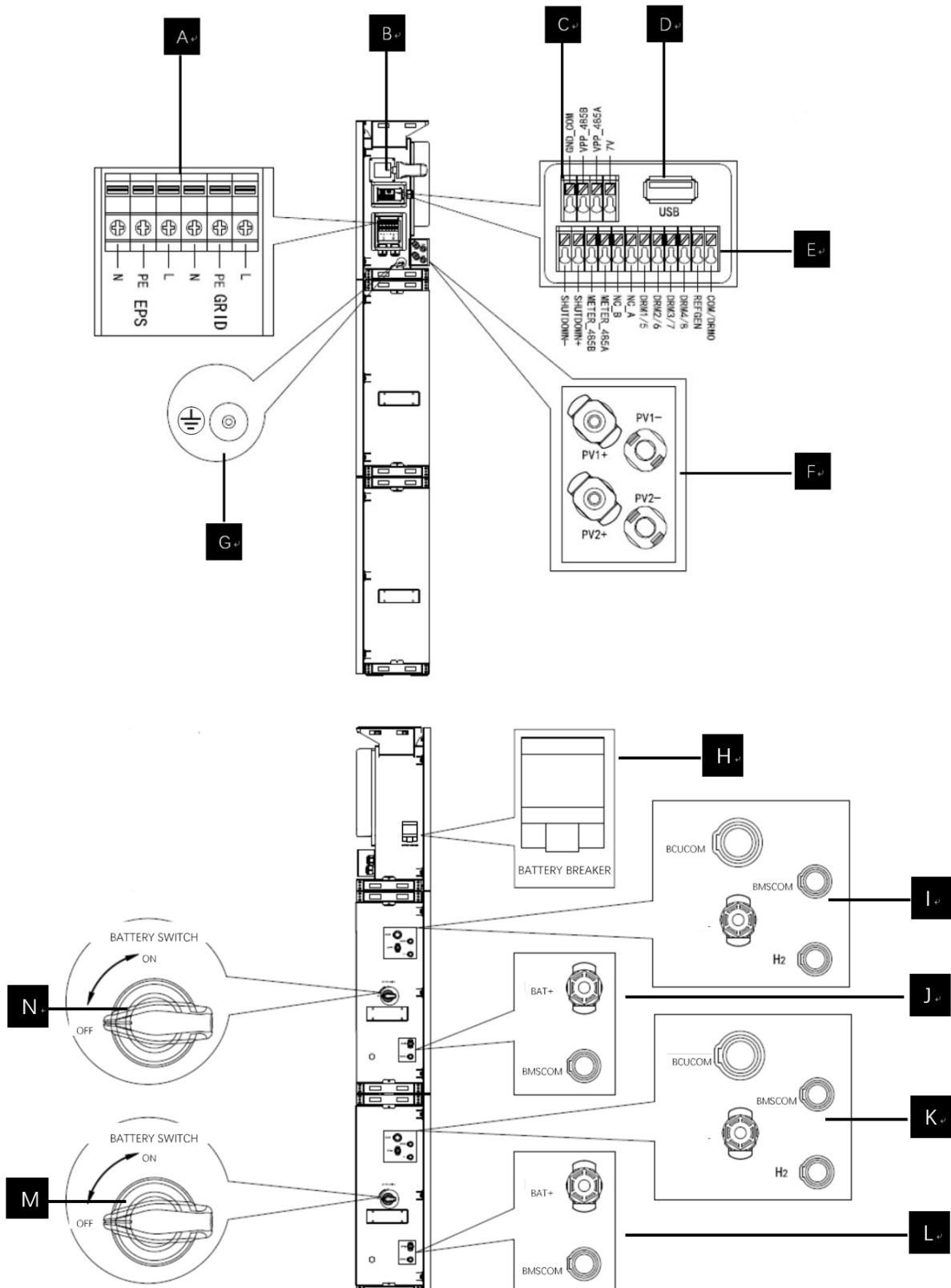

Item	Description	Tool requirements and torque values
A	Grid output & EPS output	Phillips head screwdriver 2.5 N·m
B	Wi-Fi port	Plug and play connection, no tools required
C	VPP communication port	Flat head screwdriver
D	USB port for updates	Plug and play connection, no tools required
E	Meter communication port & DRM port	Flat head screwdriver
F	PV connection area	Plug and play connection, no tools required
G	Ground screw	Phillips head screwdriver 2.5 N·m
H	Battery breaker	Rated voltage [d.c.V] 500 Rated current [d.c.A] 40 Rated insulation voltage [d.c.V] 1000 Rated impulse voltage [d.c.V] 6000 Icu [kA] 6 Ics [kA] 6 Operating temperature -30°C...70°C
I\J\K\L	Battery internal communication & power connection area	Plug and play connection, no tools required
M\N	Battery switch	The battery switch isolates the internal battery modules connected in series and should not be used to disconnect batteries under load. The battery breaker can be used to isolate batteries under load.

## 1.5. Limitation of Liability

eCactus assumes no direct or indirect liability for any product damage or property losses caused by the following.

- ◆ Product modifications, design changes, or parts replaced without eCactus's authorization;
- ◆ Modifications or attempted repairs or removal of serial numbers or seals by non-eCactus technicians;
- ◆ System designs and installations not in compliance with standards or regulations;
- ◆ Failure to comply with the local safety regulations (VDE in DE, SAA in AU, MEA and PEA in Thailand);
- ◆ Damage caused during transportation (including scratched paint caused by the product rubbing against the packaging during shipping). Any claims for damage during shipping should be made directly with the shipping or

insurance company as the container/packaging is unloaded and damage is identified;

- ◆ Failure to follow any/all of the user manual, installation guide, or maintenance guidelines;
- ◆ Improper use or misuse of the device;
- ◆ Insufficient ventilation around the device;
- ◆ Product maintenance not done to acceptable standards;
- ◆ Force majeure (including severe or stormy weather, lightning, and fires).



## 2. Installation

The product must be installed on a flat surface or platform with a load-bearing capacity of at least 300 kg. The battery box must be attached to a wall or bracket capable of supporting wall anchors and having a minimum load-bearing capacity of 300 kg. The installation location should be well-ventilated and away from flammable or explosive materials.

### 2.1. Installation Location and Environment

#### 2.1.1. General

This BESS is rated for outdoor installation and can be installed both indoors and outdoors.

The BESS is naturally ventilated. The location must be clean, dry, and adequately ventilated. Enough space should be left for unrestricted access to the unit for installation and maintenance purposes, and the system panels should not be obstructed.

The hybrid inverter should not be installed in the following locations:

- ◆ Habitable rooms;
- ◆ Ceiling or wall cavities;
- ◆ On roofs not suited for the purpose;
- ◆ Access/exit areas or under stairs/access passages;
- ◆ Places where freezing temperatures can occur, such as garages, carports, or other places such as wet rooms;
- ◆ Humid or salty environments;
- ◆ Seismic-prone areas—additional safety measures are needed;
- ◆ Sites higher than 3000 meters above sea level;
- ◆ Explosive atmospheres;
- ◆ In direct sunlight or places susceptible to significant changes in ambient temperature;

## 2.1.2. Location Restrictions

The BESS should not be installed:

- (1) Within 600 mm of any heat source, such as hot water units, gas heaters, air conditioning units, or any other similar appliances;
- (2) Within 600 mm of any exit;
- (3) Within 600 mm of any window or ventilation opening;
- (4) Within 900 mm of access to 220/230/240 VAC connections;
- (5) Within 600 mm of the side of any other device.

Leave at least 1 meter of clearance between the BESS and any emergency exits when installing the device in corridors, lobbies, or hallways to ensure a safe exit.

## 2.1.3. Barriers to Habitable Rooms

Ensure a suitable non-combustible barrier is set up between the BESS and any installation walls or structures when installing the BESS on a wall or structure connected to a living space to protect against the spread of fire to living spaces. A non-combustible barrier should be installed between the BESS and the surface of the wall or structure it is being mounted to if the surface itself is not made out of a suitable non-combustible material. Increase the distance between the BESS and any other nearby structures or objects if there is less than 30 mm between the hybrid inverter and the wall or structure separating it from living spaces.

The following spaces around the hybrid inverter must remain empty:

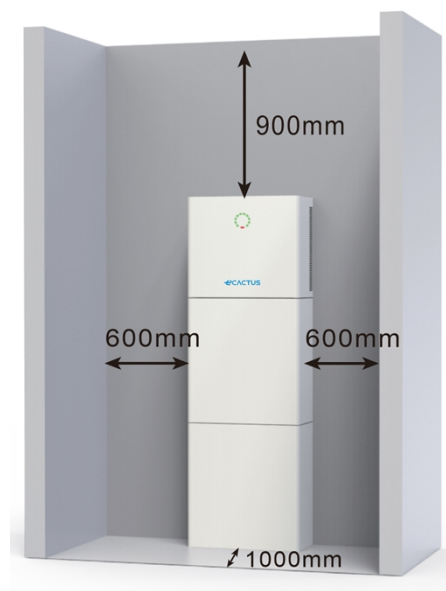

The clearance is a recommendation. Reserve sufficient clearance around the product to ensure sufficient space for installation, maintenance and heat

dissipation. If there is a local standard for the installation of energy storage systems, please define the clearance refer to the standard.

### 2.1.4. Choosing an Installation Location

Carefully select an appropriate installation location for the BESS based on the following rules to protect the BESS and facilitate maintenance.

**Rule 1.** The BESS should be installed on a solid surface capable of supporting its size and weight.

**Rule 2.** The BESS should be installed vertically or at a maximum 2° angle (Pic 1).

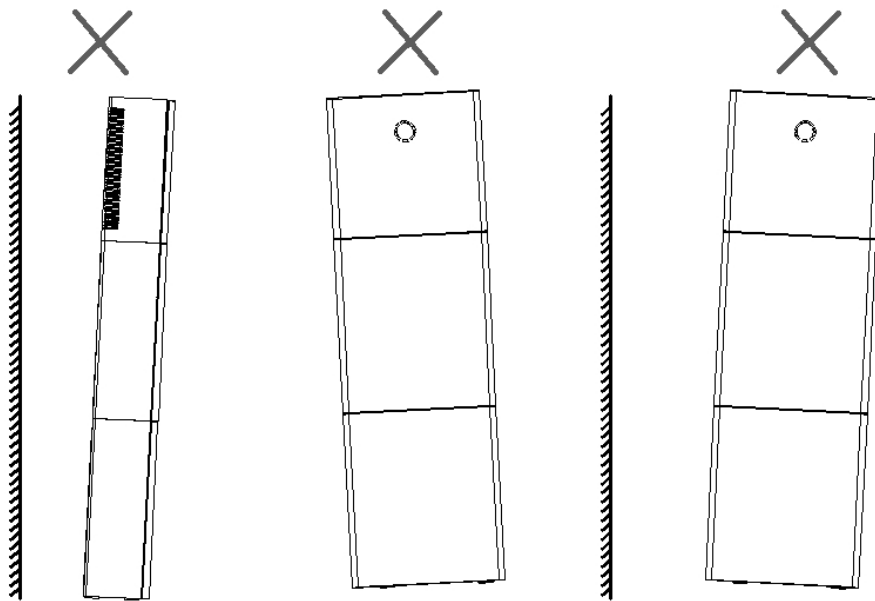

**Rule 3.** It is recommended that the BESS be installed in a proper room temperature environment.

**Rule 4.** The BESS installation location should be protected from direct sunlight or bad weather like snow, rain, or lightning.

Max. +55°C	Min. -10°C	RH. +5% -- +95%	
✓	✓	✓	Flammable materials or gas near the installation
X Direct sunlight	X Direct rain	X Snow buildup	Flammable wall

**Rule 5.** Installing the BESS at eye level will make maintenance more convenient.

**Rule 6.** The BESS product label should be clearly visible after installation.

## 2.2. Installation Steps

Unpacking the battery box and inverter box.

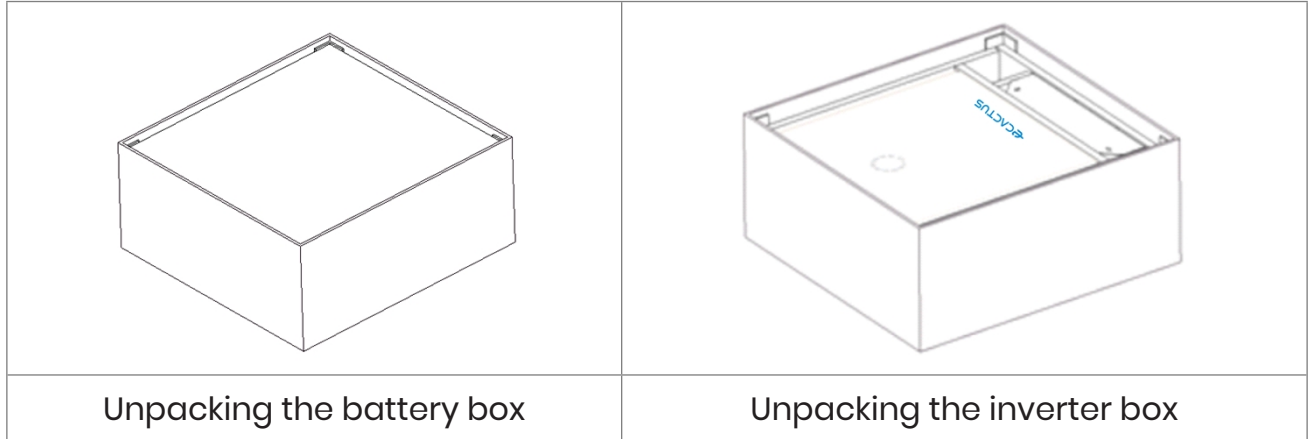

### 2.2.1. Battery Box Installation

Installation Tools:

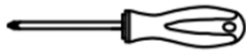

Screwdriver



Multimeter



Wire stripper

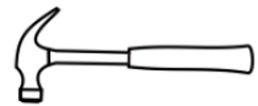

Claw hammer

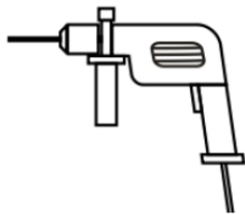

Hammer drill



Diagonal pliers

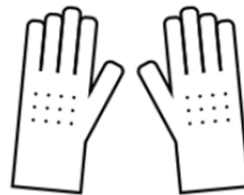

Insulating gloves

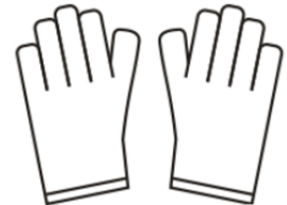

Protective gloves



Crimping pliers

**10 kWh BESS:**

Please note that the inverter and battery box are heavy. Please wear gloves and other protective equipment when moving and installing the inverter and battery box.

**Step 1:** Stick the pads onto the battery box.

Stick four of the included pads from the inverter accessory packet to the four corners of the bottom of the battery box.

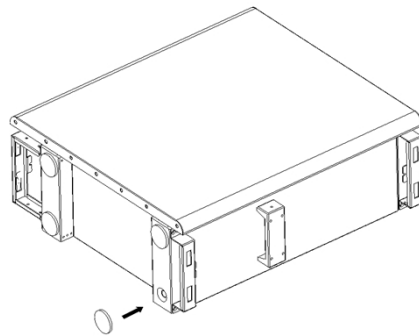

**Step 2:** Back panel pre-tightening

Remove the back installation panel from the inverter accessory packet and use two of the included M4\*10 screws to attach the back panel to the top of the battery box, as shown in the figure below:

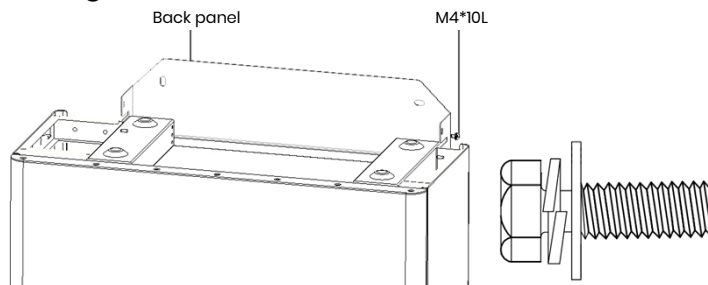

**Step 3:** Drilling holes

Position the pre-installed battery box close to the installation location, mark drilling locations according to the positions of the holes on the back panel, then angle the back panel away (or remove it), and use a Ø10 mm bit to drill the necessary holes on the installation location. Make sure that holes are more than 70 mm deep.

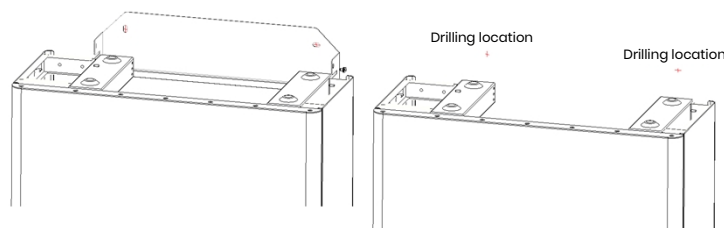

**Step 4:** Installing wall anchors

Hammer the wall anchors included in the inverter accessory packet into the pre-drilled holes so that they sit flush with the wall.

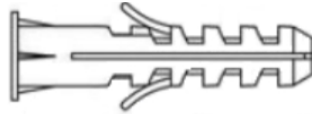

**Step 5:** Installing the battery box and back panel

Rotate the back panel in place and screw the anchor bolts into the back panel using self-tapping screws (note that the battery box is attached to the back panel). Replace the battery box, line up the anchor bolts with the drilled holes, and tighten the self-tapping screws until firmly pressed on the back panel.

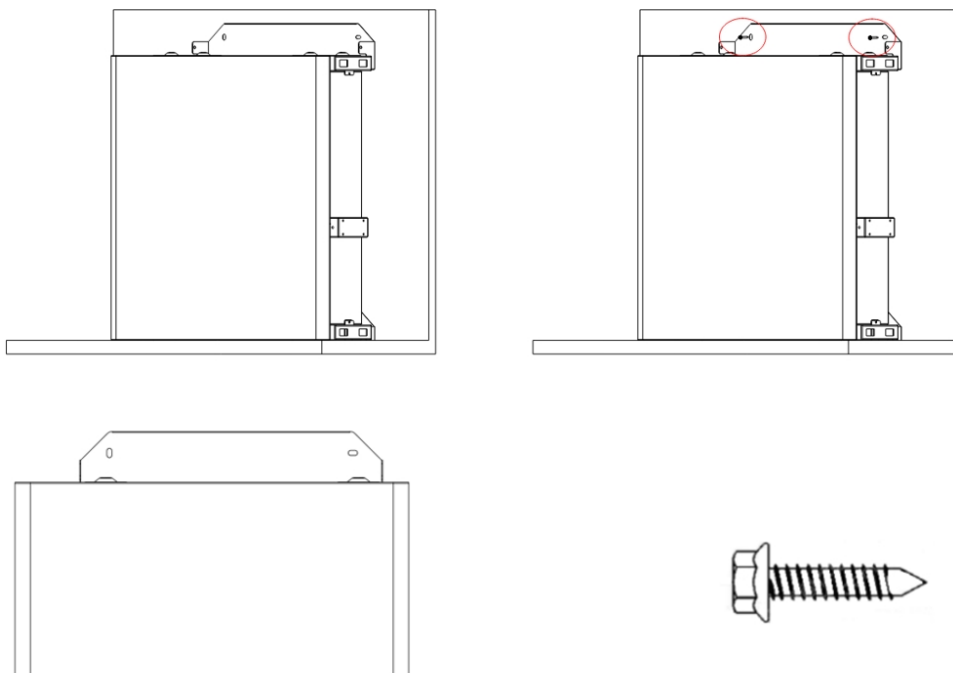

**Step 6:** Back panel pre-tightening

Remove the back installation panel from the inverter accessory packet and use two of the included M4\*10 screws to attach the back panel to the top of the battery box, as shown in the figure below.

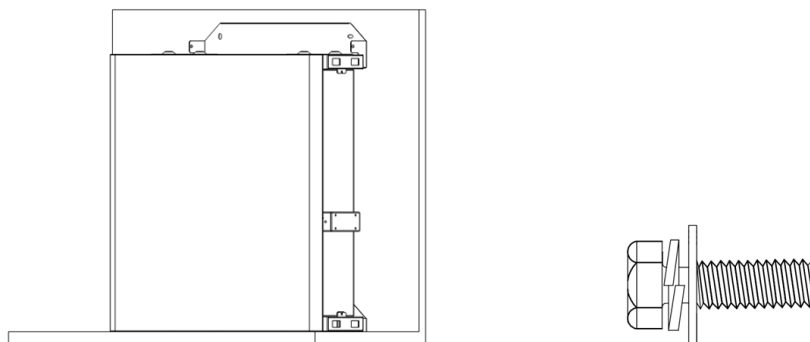

**Step 7:** Installing the second battery box

Place the second battery box flush on the top of the first battery box, taking care not to hit the back panel.

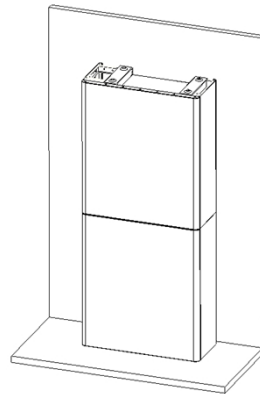

**Step 8:** Drilling holes

Position the pre-installed battery box close to the installation location, mark drilling locations according to the positions of the holes on the back panel, then angle the back panel away (or remove it), and use a Ø10 mm bit to drill the necessary holes on the installation location.

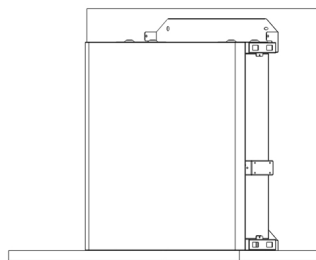

**Step 9:** Installing wall anchors

Hammer the wall anchors included in the inverter accessory packet into the pre-drilled holes so that they sit flush with the wall.

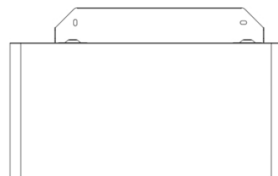

**Step 10:** Installing the battery box and back panel

Rotate the back panel in place and screw the anchor bolts into the back panel using self-tapping screws (note that the battery box is attached to the back panel). Replace the battery box, line up the anchor bolts with the drilled holes, and tighten the self-tapping screws until firmly pressed on the back panel.

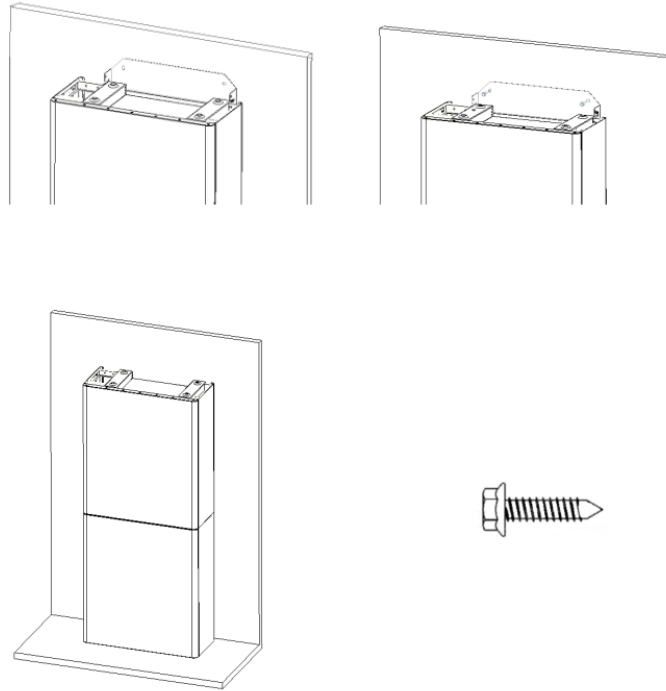

Fine-tuning the battery box:

Item	Name	Torque	Note
1	Wall anchors	4 N·m	Tune up and down
2	Tuning screws	3 N·m	Tune left and right
3	Installation screws	3 N·m	Tune front and back

**Step 11:** Attach the upper and lower connection panels. (Torque 2.5 N.m)

Upper and lower connection panels

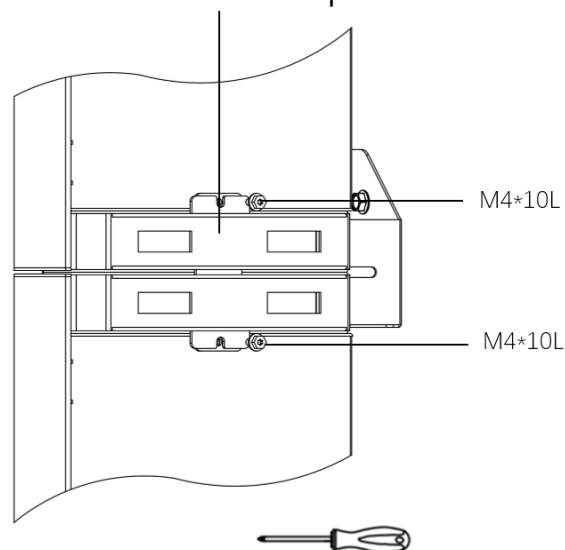



### 2.2.2. Inverter Box Installation

**Step 1:** Take the inverter out of its box and place it flush on top of the battery box. Be careful not to damage the inverter cables when moving them.

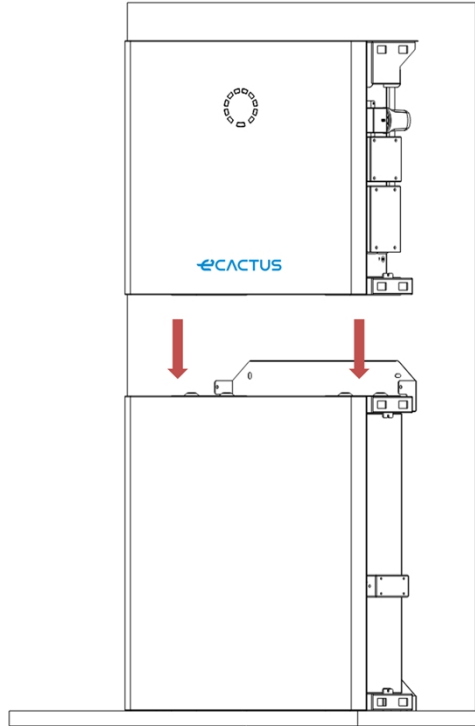

**Step 2:** Install the upper and lower connection panels to the inverter box. Attach the back panel to the inverter using M4\*10L stainless steel screws, then attach the upper and lower connection panels to the battery box and inverter, and finally screw the back panel into the inverter. (Torque 2.5 N.m)

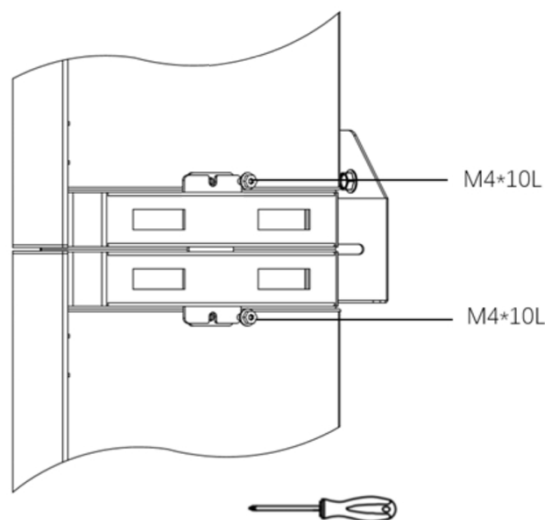

**Step 3:** Installing the Wi-Fi dongle

Insert the Wi-Fi dongle included in the accessory packet into the base and tighten the plastic nut. Torque: 2.5 N.m

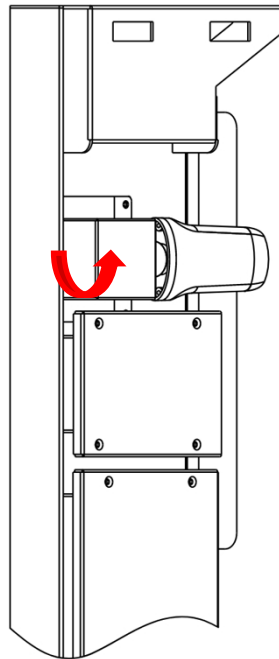

**2.3. Cable Connections**

**2.3.1. General**

**Make sure all BESS switches and breakers are in the OFF position.**

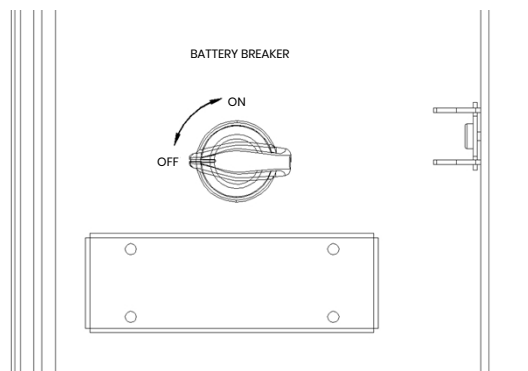

**Note:** PV array ports shall include the requirement of an additional external break switching device that conforms to the requirements AS/NZS 4777.1

### 2.3.2. Connect the Inverter Box and Battery Box

Recommended cables and connectors:

Cable Type	Cable Specification	Terminal Model
PE Cable	10 AWG	OT5-4 (Included in the accessory packet)
PV+ Cable	10 AWG (RED)	Positive DC Connector (Included in the accessory packet)
PV- Cable	10 AWG (BLACK)	Negative DC Connector (Included in the accessory packet)
Grid Cable	Please select the cable size according to the maximum input current value of GRID.	E10-12 (Included in the accessory packet)
EPS Cable	Please select the cable size according to the maximum input current value of EPS	E6012 (Included in the accessory packet)

#### 10 kWh BESS:

**Make sure all BESS switches and breakers are in the OFF position.**

**Step 1:** Remove the cable ties.

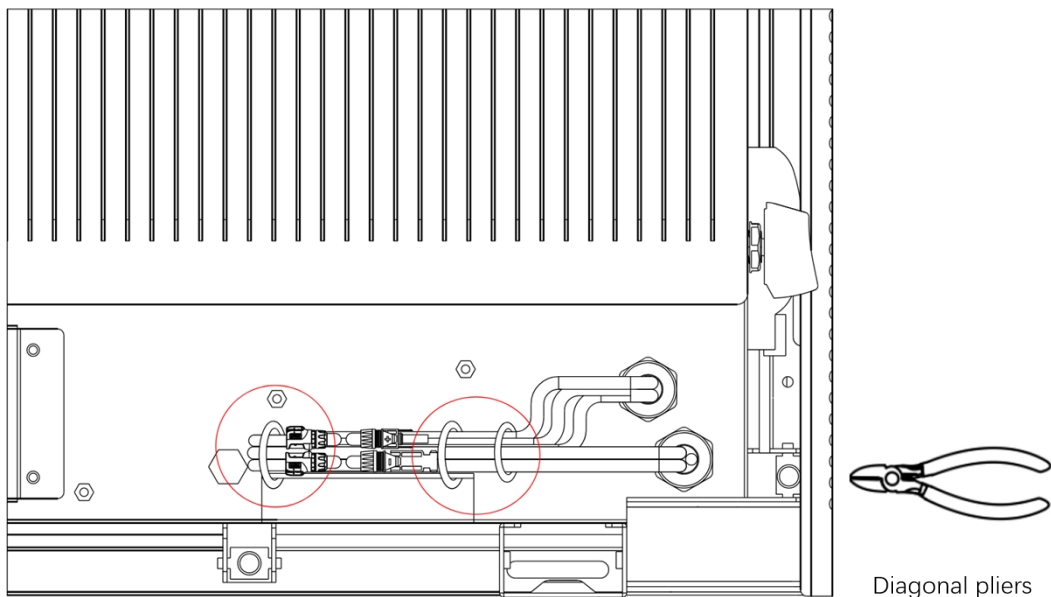

**Step 2:** First, open the waterproof cover for the corresponding connector and insert the connector according to the cable label.

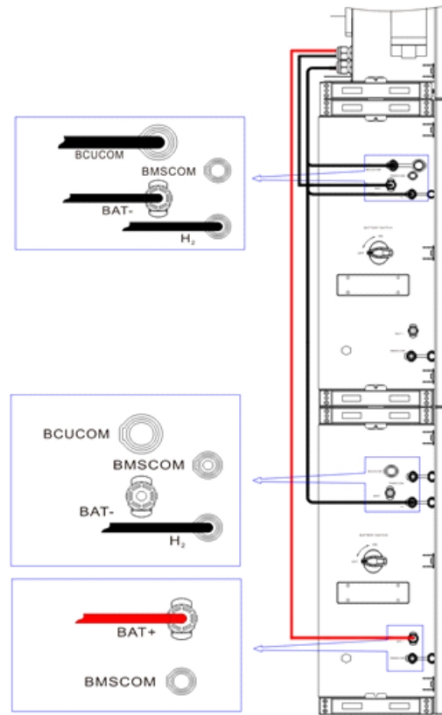

**Step 3:** Connecting the cables between the two battery boxes

Find the two cables from the inverter box and insert them into the appropriate connector based on the cable number.

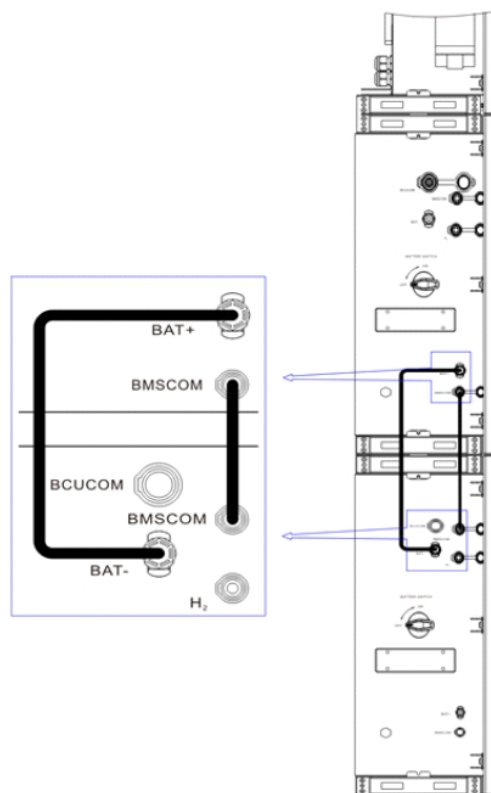

**Step 4:** Connecting the communication cables

Open the communication cover panel and complete the connections based on the printed instructions on the communication cover panel. Loosen the waterproof connector's press nut, remove the seal, then insert the conductor into the hole, connect the appropriate cable, re-tighten the press nut, and lock the waterproof cover panel in place.

**Step 5:** GRID and EPS cables

Open the waterproof cover panel and complete the connections based on the printed descriptions on the box. Loosen the waterproof connector's press nut and remove the seal. Then, insert the cable into the hole.

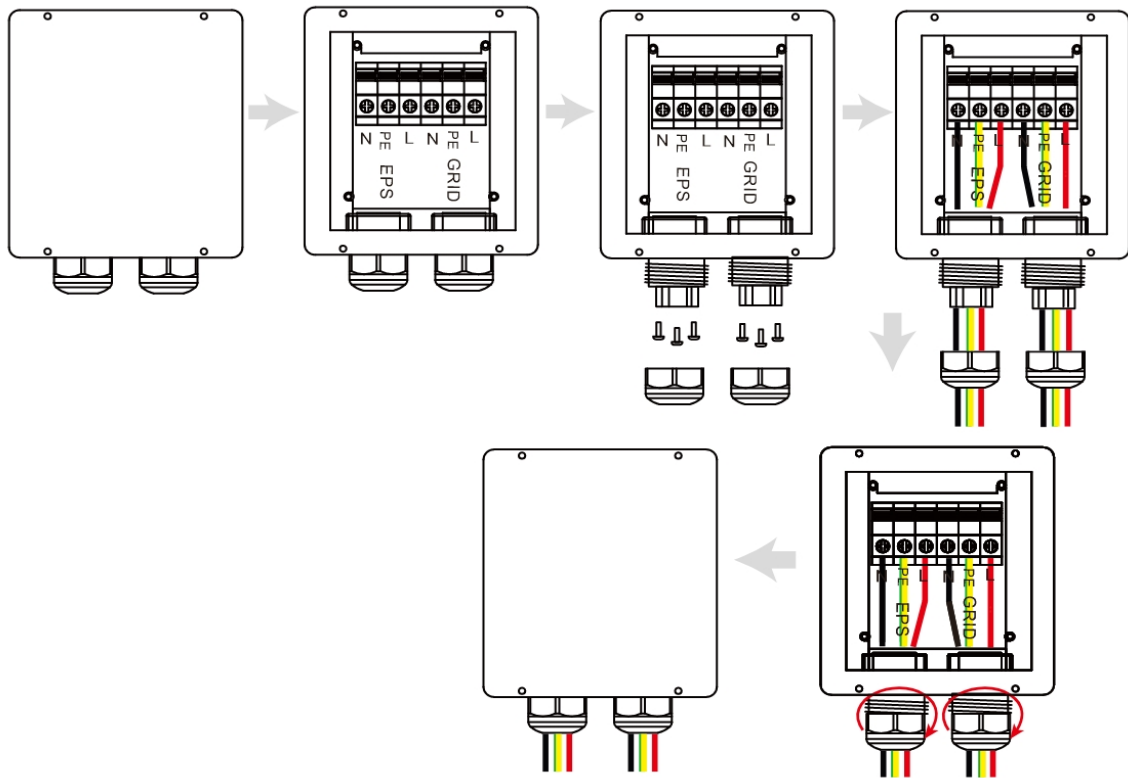

**Note:** The cable should be shorter than 30 meters.

**Note:** Please select the cable size according to the maximum input current value of EPS and GRID.

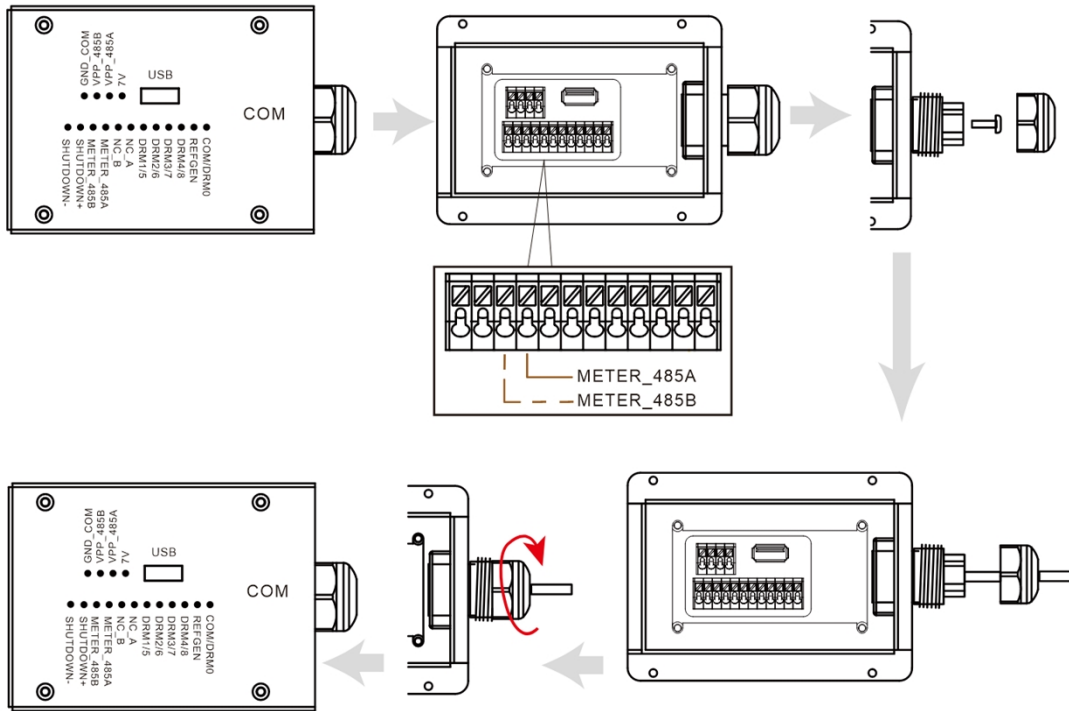

Pressed cable:

1. Peel off a 7 mm length of the L/N/PE cable end.

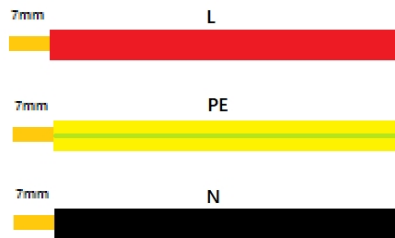

2. Place the E10-12 terminal onto the cable and crimp it tightly using pressure line clamps.

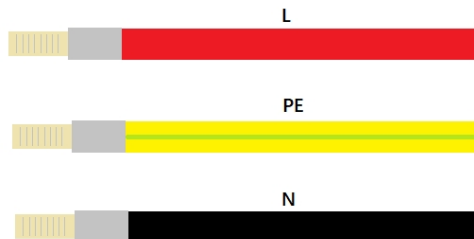

3. Insert the terminal into the wiring seat, use a Phillips head screwdriver to tighten the screws (2.5 N.m), and tighten the nut.

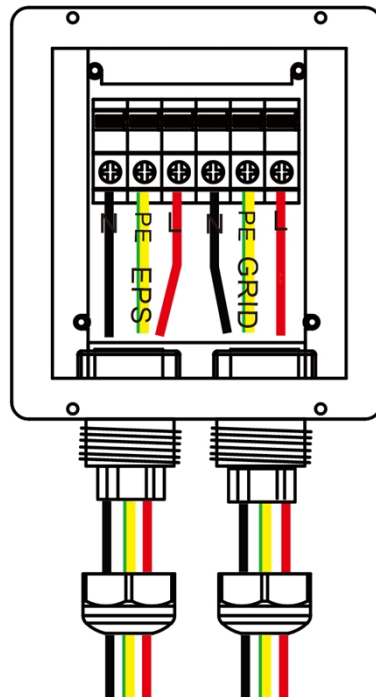

4. Attach the waterproof cover and lock it in place.

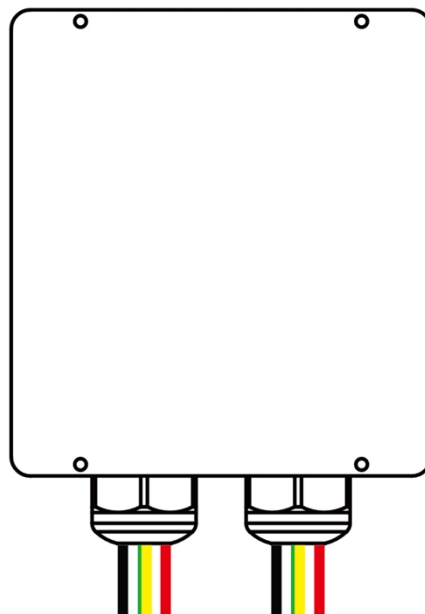

**Note:**

**Back-up function notes:**

- Some external factors may cause the backup switching time to exceed 10 ms, and loads reliant on a constant stable energy supply should not be connected.
- Very high inrush current surges from loads such as fixed-frequency air conditioners and high-power pumps may cause the inverter to switch to the overload protection state.

**Step 6:** Connect the PE cable.

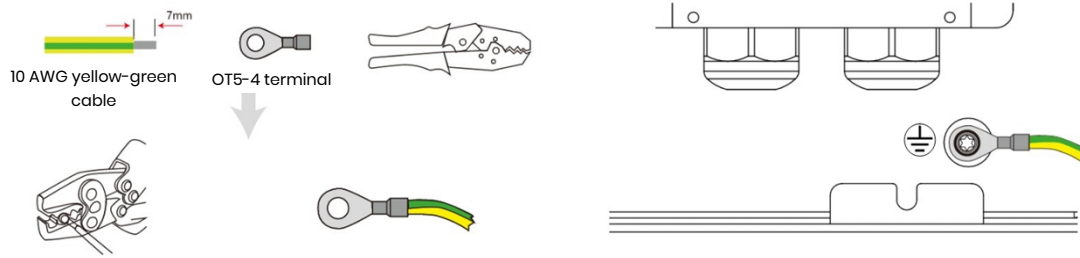

**Step 7:** Connect the PV cables.

1. Crimp the terminal;

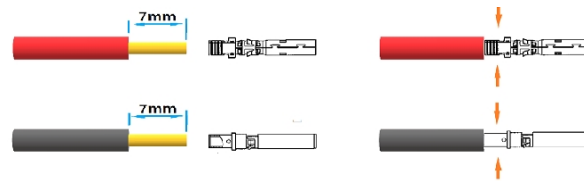

Legend	Description	Value
A	Outer Diameter	5.5–8.0 mm
B	Insulated Cable Length	7 mm
C	Conductor Core	10 AWG

2. Insert the terminal into the connector and lock the nut;

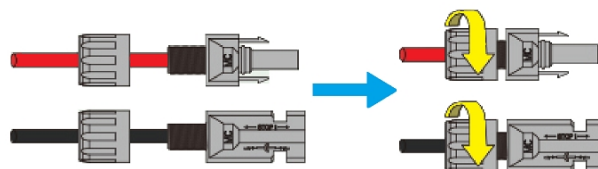

3. Complete the connection.

For Australia and New Zealand the PV SWITCH is not integrated. An external isolation device for PV array ports is needed. The external isolation device shall conform to the requirements AS/NZS 4777.1

External isolator for PV arrays table

Manufacturer	Model
PROJOY Electric Co., Ltd	PEDSC100R-EL32R-4 (4MC4)



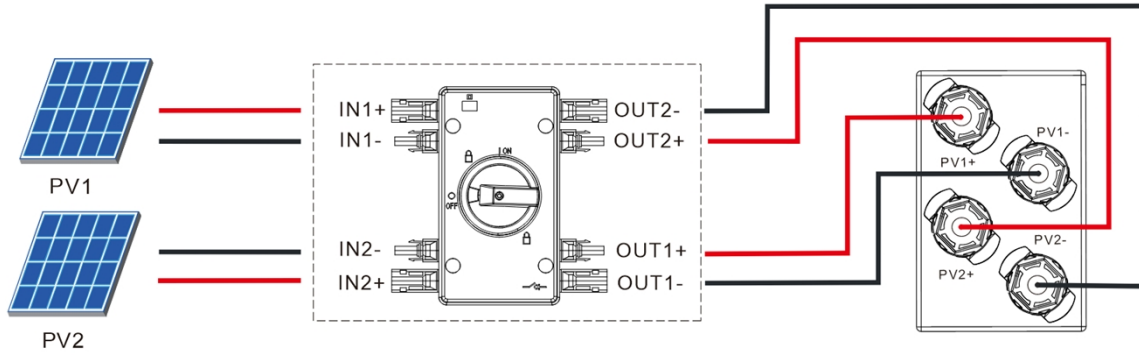

Pay attention to PV string polarity, and do not connect them in reverse order. Otherwise, the inverter might be damaged.

### 2.3.3. System Wiring Diagram

Please use an appropriate breaker based on the following specifications:

#### Three Phase Meter

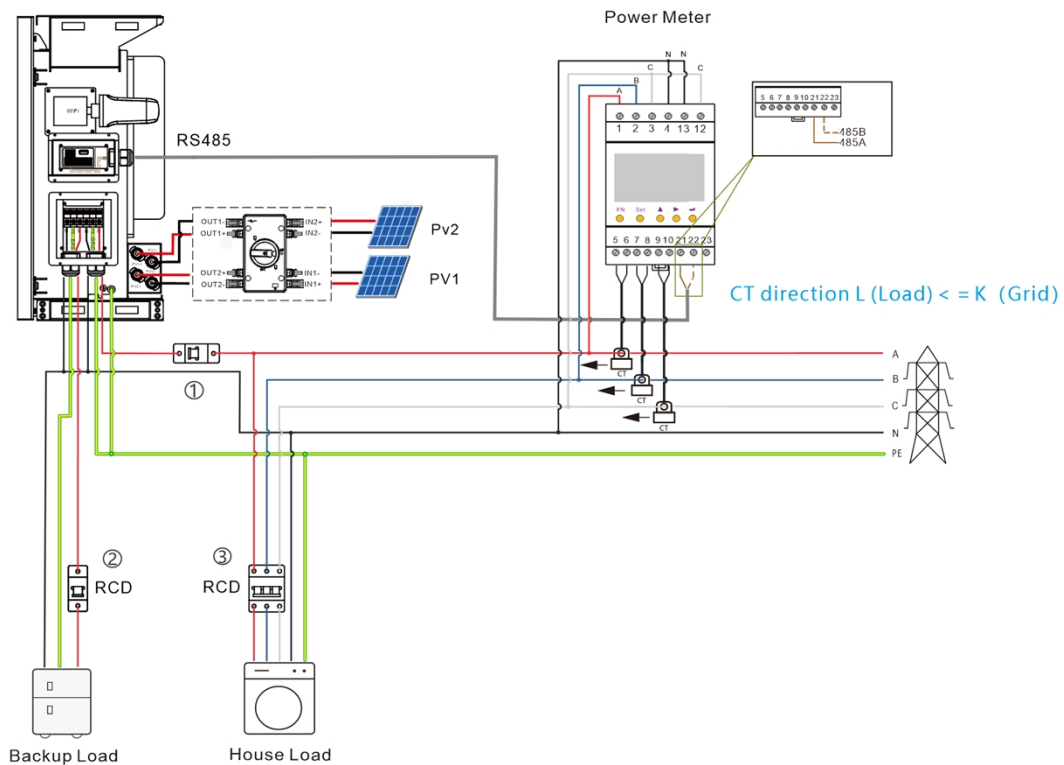

### Single Phase Meter

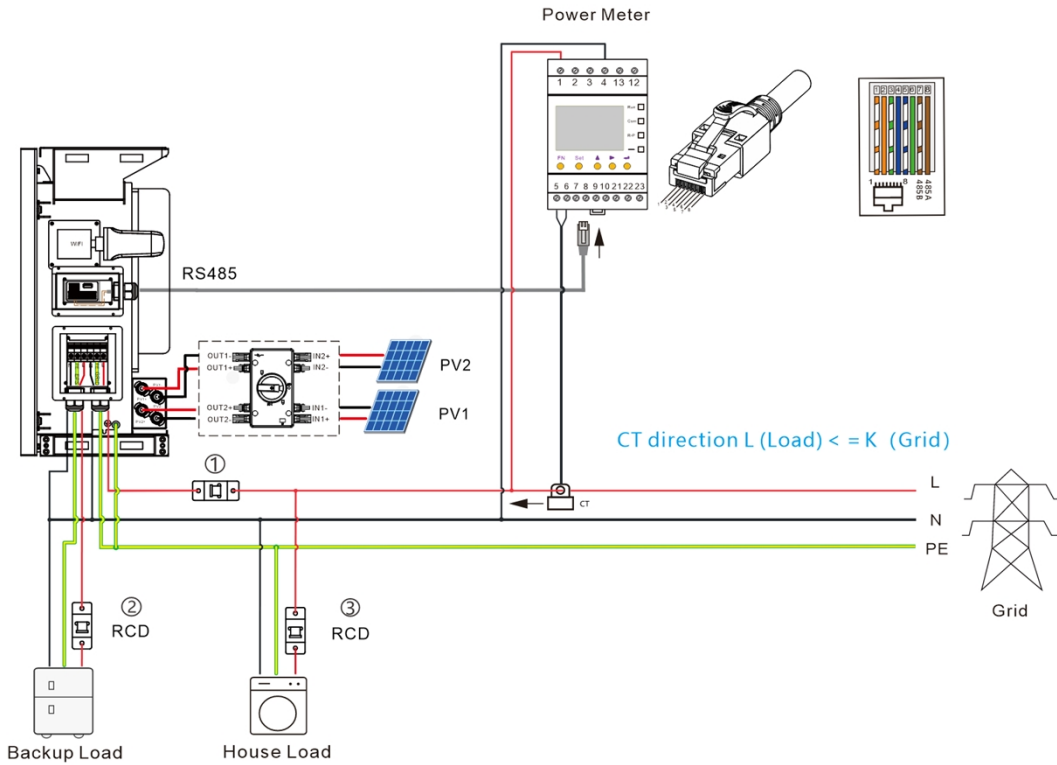

#### Choose the correct breaker:

Model	①	②	③ ④
WH-SPHA3.6H- 5.12kWh/10.24kWh	25 A/230 V AC breaker	25 A/230 V AC breaker	According to residential load (generally already installed in the grid distribution box)
WH-SPHA5.0H- 5.12kWh/10.24kWh	32 A/230 V AC breaker	32 A/230 V AC breaker	
WH-SPHA6.0H- 5.12kWh/10.24kWh	32 A/230 V AC breaker	32 A/230 V AC breaker	

#### ● System Connection Diagrams

**Note:** Under Australian safety standards, the On-Grid and Back-Up neutral wires must be connected together, or the Back-Up function will not work.

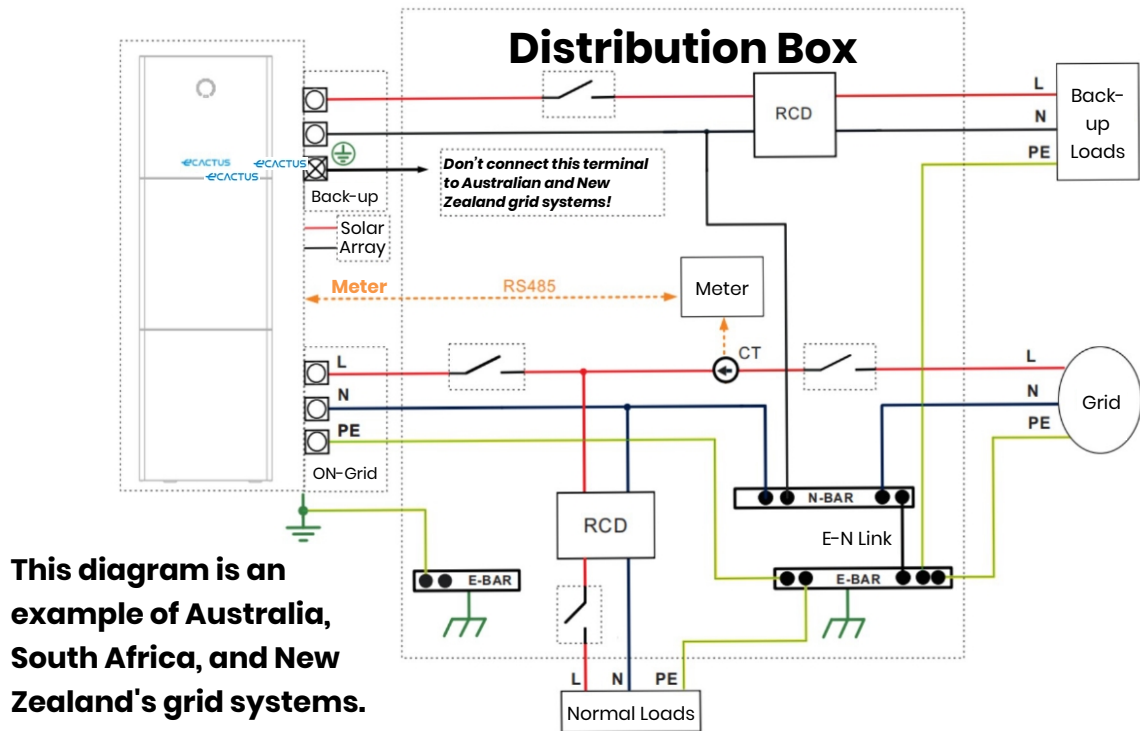

**Note:** The backup PE line and earth bar should be properly and effectively grounded. Otherwise, the backup function may not work as intended during grid failures.

### 2.3.4. Power Meter

Mount and connect the electricity meter at the grid transition point so that it can measure grid reference and feed-in power.

CT meter ratio and accuracy table

Manufacturer	Model	CT ratio	Accuracy
Acrel Co., Ltd	ACR10R-D16TE	3000	0.5 level

### 2.4. DRED Connection

DRED is used in Australia and New Zealand installations to support multiple demand response modes.

Demand response mode	Requirements
DRM0	Disconnected

Demand response mode	Requirements
	Import power = 0 & Generate power = 0
DRM1	Import power = 0
DRM2	Import power < 50%
DRM3	Import power < 75%
DRM4	Import power = Not limited
DRM5	Generate power = 0
DRM6	Generate power < 50%
DRM7	Generate power < 75%
DRM8	Generate power = Not limited

● DRED connector:

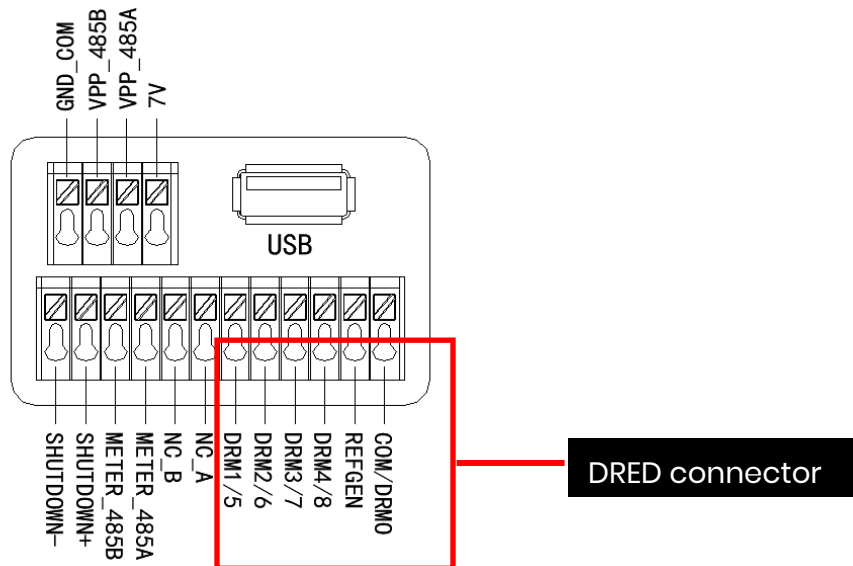

● DRED Wire connection

Open the communication cover panel and complete the connections based on the printed instructions on the communication cover panel. Loosen the waterproof connector's press nut, remove the seal, then insert the conductor into the hole, connect the appropriate cable, re-tighten the press nut, and lock the waterproof cover panel in place.

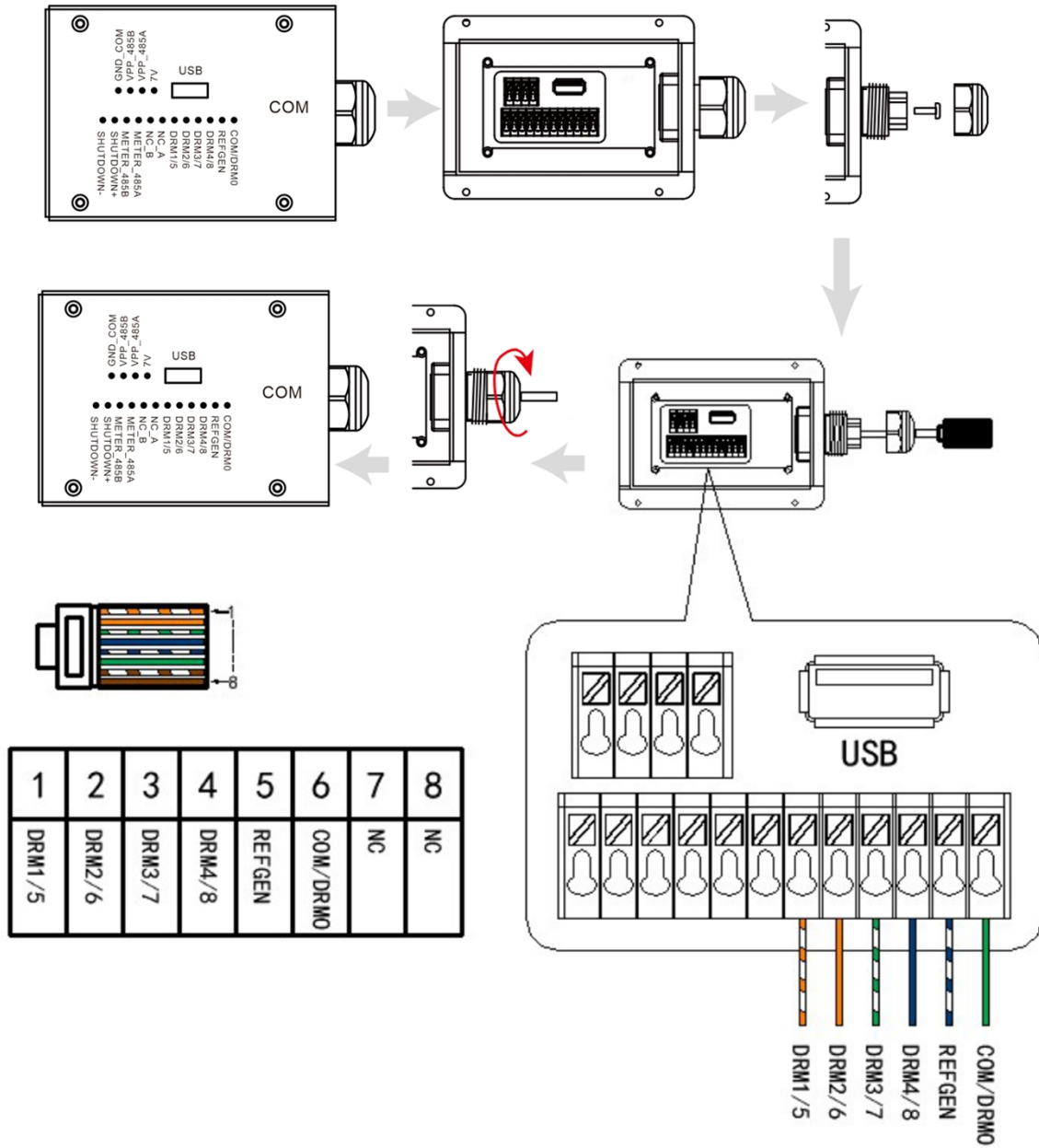

### 3. System Operation

#### 3.1. Turning on the BESS

**Warning: Please double-check the installation before turning on the system.**

**Step 1:** Turn the battery switch for every battery module to the ON position.

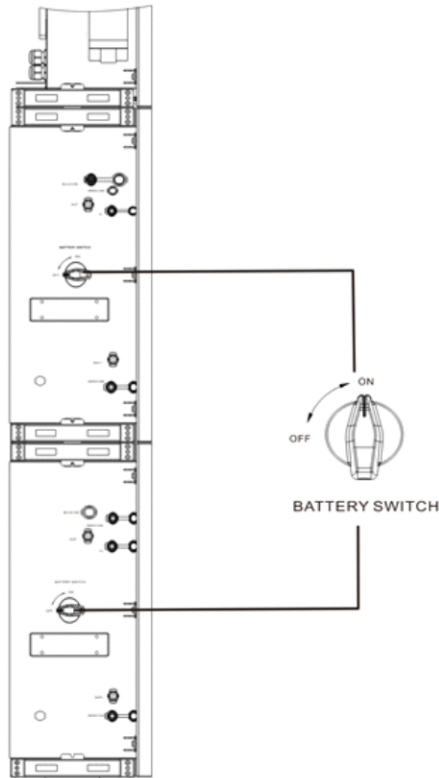

**Note:**

The battery switch isolates the internal battery modules connected in series and should not be used to disconnect batteries under load. The battery breaker can be used to isolate batteries under load.

**Step 2:** Open the battery breaker cover and turn the battery breaker to the ON position.

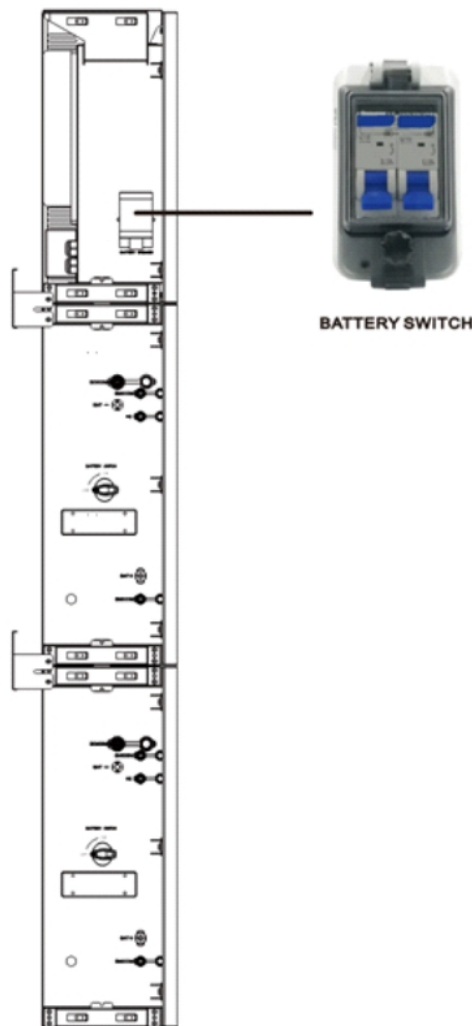

**Step 3:** Turn on the PV switch.

**Note:** The PV SWITCH is not included in models for Australia and New Zealand.

**Note:** The external isolation devices for PV array ports shall include the requirement of an additional external break switching device that conforms to the requirements AS/NZS 4777.1

**Step 4:** Turn on the grid breaker.

**Step 5:** Turn on the backup breaker if a backup load is being used.

**Step 6:** Close the battery breaker cover.

**Step 7:** Configure the Wi-Fi dongle (Only when turning on the system for the first time).

Please follow the instructions in Chapters 4 and 5.

### 3.2. Turning off the BESS

**Step 1:** Disconnect the backup load where applicable, and then turn off the backup breaker.

**Step 2:** Turn off the grid breaker.

**Step 3:** Turn off the PV switch.

**Step 4:** Open the battery breaker cover and turn the battery breaker to the OFF position.

**Step 5:** Turn the battery switch for every battery module to the OFF position.

**Step 6:** Close the battery breaker cover.

### 3.3. Emergencies

#### 3.3.1. Emergency Procedures

Turn off the main grid breaker directly feeding the Battery Energy Storage System (BESS) and turn off all BESS switches if the WH-SPHA BESS appears to be malfunctioning. Please immediately contact eCactus for detailed instructions.

**WARNING:** Do not open the BESS upper cover panel by yourself.

#### 3.3.2. First Aid Procedures

Avoid touching any liquid or gas leaking out of battery modules. Immediately do the following upon exposure to leaked battery liquids or gases:

**Skin contact:** Remove any contaminated clothes and rinse the affected area with plenty of water or run it under a shower for at least 15 minutes. Seek medical attention immediately.

**Eye contact:** Immediately flush the eyes with plenty of water for at least 15 minutes, occasionally lifting the upper and lower eyelids. Seek medical attention immediately.

**Inhalation:** Cover the victim in a blanket, move them into the fresh air, and keep them calm. Seek medical attention immediately. Begin artificial respiration immediately in the event of shortness of breath or difficulty breathing, or asphyxia (choking).

**Ingestion:** Give the patient at least 2 glasses of milk or water to drink. Induce vomiting unless the patient is unconscious. Seek medical attention immediately.

#### 3.3.3. Firefighting Measures

**Extinguishing media:** Dry powder, sand, carbon dioxide (CO<sub>2</sub>), or water. Fire precautions and protective measures:

**Flammable properties:** Lithium-ion batteries contain a flammable liquid electrolyte that may vent, ignite, or produce sparks when subjected to high



temperatures ( $> 150^{\circ}\text{C}$ ) or when damaged or improperly used (e.g., mechanical damage or overcharging). Burning cells can ignite other batteries close by.

**Explosion data:** Severe mechanical abuse may rupture batteries. Batteries may explode when exposed to fire.

**Special protective equipment for firefighters:** Wear full protective gear and self-contained breathing apparatus with a full face mask in a pressure-demand or other positive pressure mode in case of fire.

## 4. ECACTUS CONFIGURATION & WI-FI RELOAD

- This part demonstrates the eCactus configuration step by step.

### 4.1. Preparations

1. The hybrid inverter must be connected to PV power only.
2. A router connected to the Internet is required to connect to the ECOS application center.
3. Android or iOS smartphone.

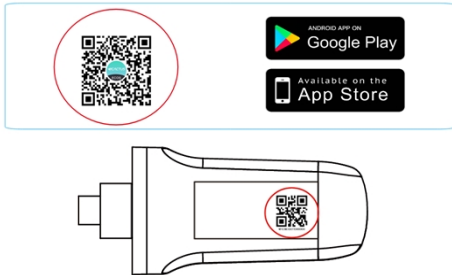
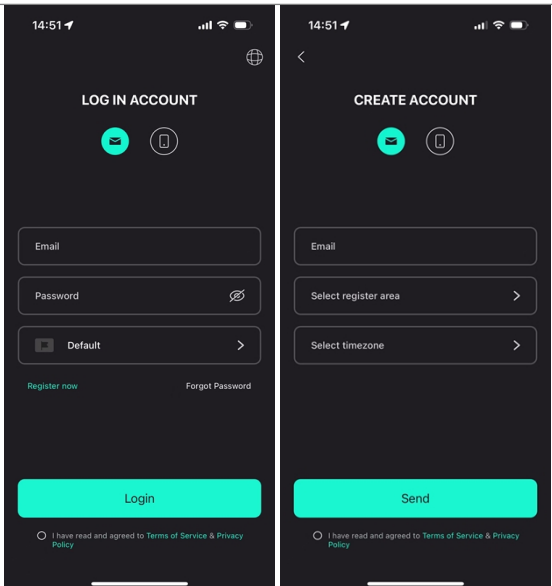
<p><b>STEP 1</b></p> <ol style="list-style-type: none"> <li>1. Scan the QR code on the front of the device to install the Android or iOS version of the ECOS app, depending on your operating system.</li> </ol>	
<p><b>STEP 2</b></p> <ol style="list-style-type: none"> <li>1. Open the ECOS app and tap the sign-up button to register a new user account.</li> <li>2. Follow all the instructions given during the sign-up process to successfully connect the device to ECOS.</li> <li>3. The product ID QR code required for connection can be found on the included Wi-Fi dongle installed on the right side of the device.</li> </ol>	

## NOTE

1. Please ensure the correct router password is entered.
2. Make sure that the Wi-Fi dongle's wireless network connection is strong.
3. If everything is set up properly, the Wi-Fi LED on the inverter will change from slowly flashing to quick flashing and then become solid, indicating that eCactus has successfully connected to the Wi-Fi network.

### 4.2. Wi-Fi Reset & Restore

Wi-Fi Reset: Reconfigure the Wi-Fi dongle, and Wi-Fi settings will be reprocessed and saved.

Wi-Fi Restore: Restore the Wi-Fi dongle settings back to the default factory settings.

**Wi-Fi Reset:**

Please use your eCactus ECOS app to reset the Wi-Fi configuration. Navigate to Settings and My Devices, access the Wi-Fi Configuration page, and follow the instructions to complete the Wi-Fi process.

**Wi-Fi Restore:**

You also need to configure Wi-Fi network after set Wi-Fi dongle back to factory setting.

**Wi-Fi Reset:**

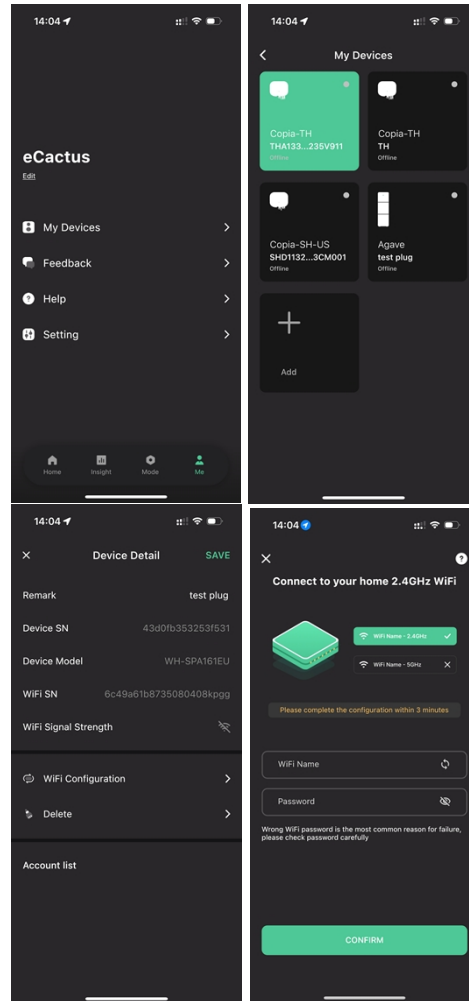

**Wi-Fi Restore:**

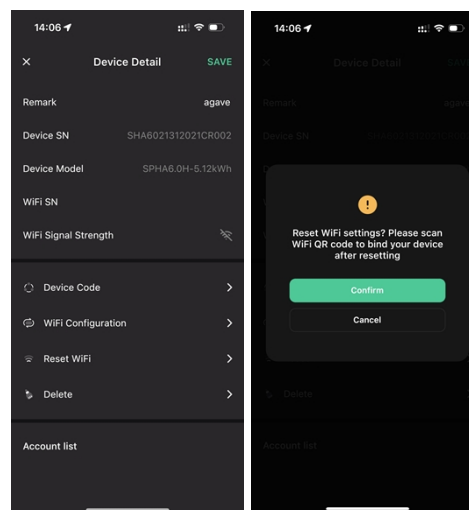

### 4.3. Change Password & Delete Account

#### Change Password

You can change your password by navigating to “**Settings**” >> “**Security**” >> “**Change Password**” and entering your Original Password to set a new password.

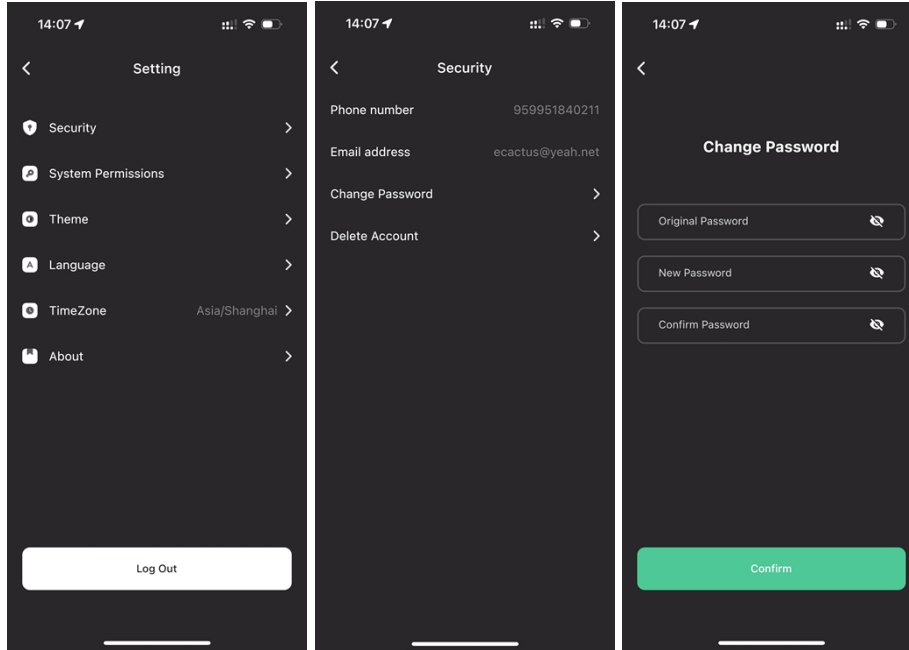

If you forget your password, you can reset your password by tapping “**Forgot Password**” on the login page and entering the verification code sent to your email address.

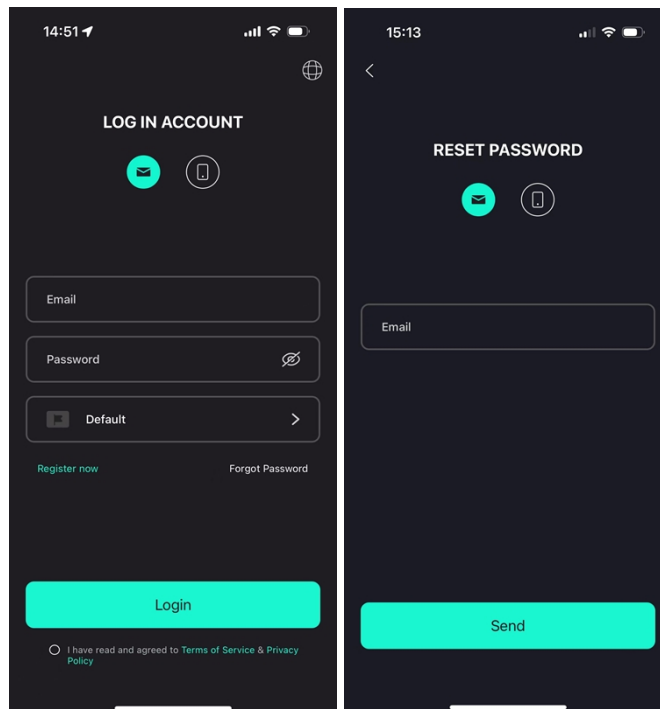

## Delete Account

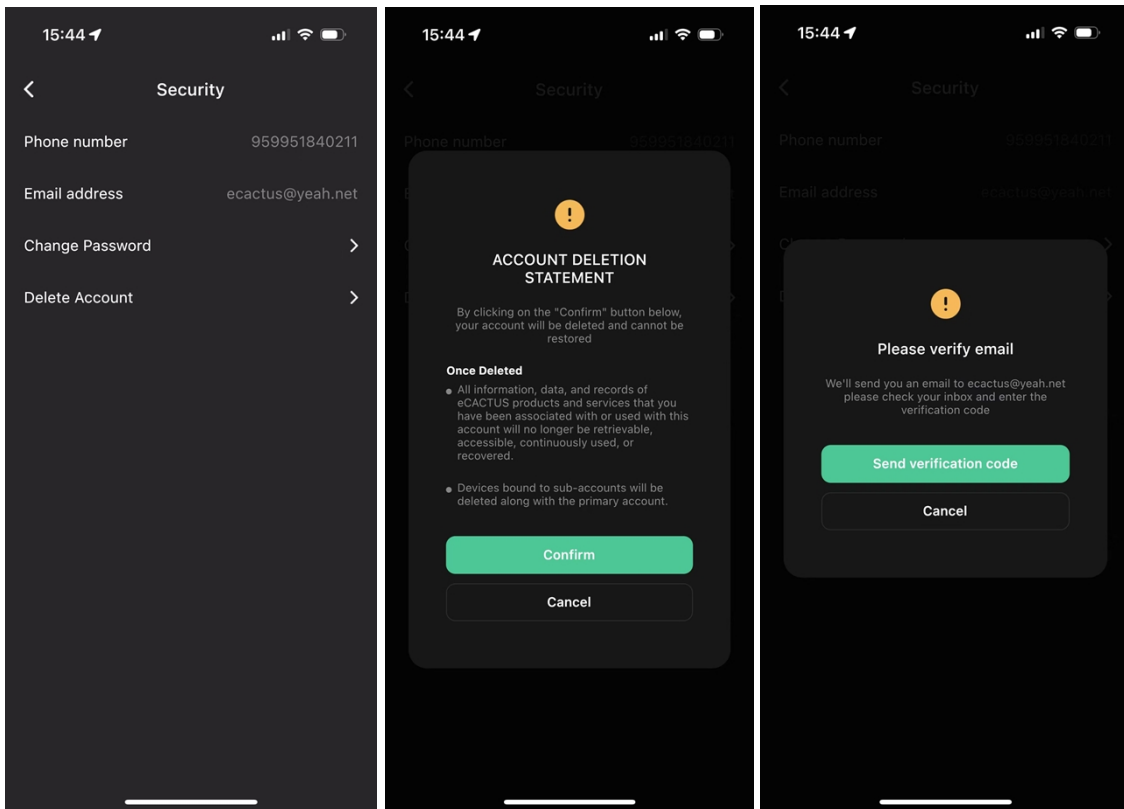

You can delete your account and data by navigating to **“Settings”** >> **“Security”**>> **“Delete Account.”** Please read the statement carefully before deleting your account.

**Notice:** You have 7 days to log back in and cancel your deletion request. Once deleted, your account and all associated data will be erased and cannot be recovered. When complete, we will send an email to your ECOS account to inform you that your account has been successfully deleted.

#### 4.4. Installing the Side Panels

Confirm that the left and right side panels are properly installed after verifying that the BESS is working properly:



## 5. EMS Configurations

Energy management system (EMS) configurations can be set via the eCactus app or online website.

### Three working modes can be configured:

#### 1. Self-Powered:

eCactus will manage residential power to minimize power grid reliance.

#### 2. Time-based Control:

Batteries will be charged and discharged as configured.

#### 3. Backup:

eCactus will not discharge the battery unless the power grid is off. When this happens, eCactus will provide residential power through the batteries.

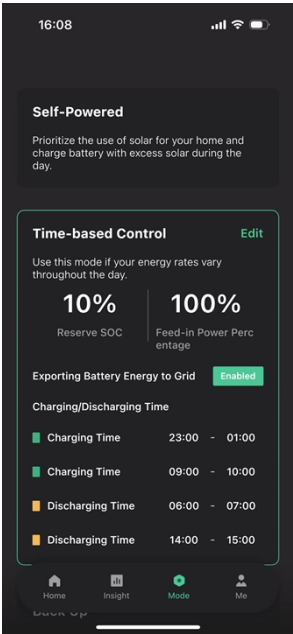
<p><b>Working Modes:</b></p> <p>Navigate to the Customize tab and select one of the three operation modes via the eCactus ECOS app.</p>	 <table border="1"><caption>Charging/Discharging Time</caption><thead><tr><th>Mode</th><th>Start Time</th><th>End Time</th></tr></thead><tbody><tr><td>Charging Time</td><td>23:00</td><td>01:00</td></tr><tr><td>Charging Time</td><td>09:00</td><td>10:00</td></tr><tr><td>Discharging Time</td><td>06:00</td><td>07:00</td></tr><tr><td>Discharging Time</td><td>14:00</td><td>15:00</td></tr></tbody></table>	Mode	Start Time	End Time	Charging Time	23:00	01:00	Charging Time	09:00	10:00	Discharging Time	06:00	07:00	Discharging Time	14:00	15:00
Mode	Start Time	End Time														
Charging Time	23:00	01:00														
Charging Time	09:00	10:00														
Discharging Time	06:00	07:00														
Discharging Time	14:00	15:00														



## 6. Troubleshooting

	Issue	Solution
1	Red LED flashing every 0.5 seconds	Meter Communication Fault. Please check whether the power supply & communication cables are properly connected in accordance with local standards.
2	Red LED flashing every 2 second	Battery Communication Fault. Please check whether the PCS is properly connected to the battery box, and make sure that the battery switch and breaker are both in the ON position.
3	Abnormal ECOS Energy Flow Monitoring	Please check whether the power supply and CT have been properly installed according to the installation manual.
4	All the LEDs are off	Please check whether the voltage at each port is within the normal range.
5	SOC mis-indicates and fluctuates after initial installation	Do nothing, and the device will self-correct itself as soon as the battery is fully charged or discharged.
6	Battery completely depleted	We highly recommend disconnecting the battery ASAP during installation or when the device is on standby to avoid serious depletion and damage caused by extreme power consumption over a long period of time. Please contact after-sale services for technical support in the event of serious battery depletion.
7	Code DSP_1	PV1 overvoltage. Please check whether the open circuit voltage is within the normal voltage range.
8	Code DSP_2	PV1 overcurrent. Please check whether PV1 is correctly connected.
9	Code DSP_3	PV2 overvoltage. Please check whether PV2 is within the rated voltage range.
10	Code DSP_4	PV2 overcurrent. Please check whether PV1 is correctly connected.
11	Code DSP_9	Please check whether PV is within the normal voltage range.
12	Code DSP_10	No grid power. Please check whether the grid voltage is normal.

13	Code DSP_11	Grid voltage fault. Please check whether the grid voltage is within the normal range.
14	Code DSP_12	Grid current fault. Please check whether the EPS load power is within the normal range.
15	Code DSP_13	Grid frequency fault. Please check whether the grid frequency is within the normal range.
16	Code DSP_14	Overheat fault. Please check whether the cooling system is working properly.
17	Code DSP_16	Current over-leak fault. Please check the solar panel and device wiring.
18	Code DSP_17	Isolation resistance fault. Please check the solar panels and wiring system.
19	Code DSP_26	Battery voltage fault. Please check whether the battery voltage is within the normal range.
20	Code DSP_37	EPS voltage fault. Please check whether the EPS load power is within the normal range.
21	Code DSP_38	EPS current fault. Please check whether the EPS load power is within the normal range.
22	Code DSP_39	EPS overload fault. Please check whether the EPS load power is within the normal range.
23	Code DSP_40	EPS short circuit fault. Please check whether the EPS load power is within the normal range.
24	Code DSP_41	Earth & Neutral wire fault. Please check whether the earth and neutral wires are properly wired in line with standard requirements.

25	What should I do if I forget my ECOS password?	Please visit the ECOS website or use the app, tap "Forgot Password," enter your email address for verification, and follow the instructions to reset your password.
26	How can I change my ECOS password?	Log into ECOS and navigate to "Settings" >> "Security" >> "Change Password" to enter your new password.
27	How can I delete my device account?	Log into ECOS, then navigate to "Security" >> "Delete Account." Complete email verification to request Account Deletion. Deletion requests can be canceled by logging in within 7 days after requesting account deletion. All account data will be deleted and will not be recoverable. Please think twice before deleting your account.
28	How can I share my ECOS account with my family members?	The first ECOS registered will be recognized as the master account, and others can scan the device code shared by the master account. Please navigate to "Settings" >> "My Device" >> "Device code" to share the code.
29	Why is there no data on the home page?	<p>The device may be offline. 1- Check whether your Wi-Fi is working; 2- Check whether the LED is on; 3- Check whether the Wi-Fi dongle is properly connected;</p> <p>Data may take a while to upload, after which ECOS will be bound to the device.</p> <p>Poor mobile phone reception. Check whether the internet is working properly and try to restart ECOS.</p>

30	Adding multiple devices to ECOS	Log in to the ECOS app and tap the “+” on the top left of the home page. Scan the QR code on the Wi-Fi dongle to add new devices. Or navigate to “Setting” >> “Devices” and tap the “+” to add more devices.
31	How can I delete my device account?	Log in to ECOS and navigate to “Setting” >> “My Devices,” select the device account, and tap the top right of the screen to delete the device.
32	Why is the device offline	<p>There are many possible reasons for the device to be offline.</p> <ol style="list-style-type: none"> <li>1. Check whether the Wi-Fi network is working properly</li> <li>2. Check whether the LED is on</li> <li>3. Check whether the LED on the Wi-Fi dongle is on</li> </ol>
33	Why can't I search for and find the Wi-Fi dongle hotspot?	<ol style="list-style-type: none"> <li>1. Check whether the LED is on</li> <li>2. Check whether the LED on the Wi-Fi dongle is on</li> <li>3. Restart or reconnect the Wi-Fi dongle</li> </ol>
34	Why is no internet connection found when returning to other interfaces after configuring ECOS via WLAN?	Disconnect your mobile phone from the WLAN, and reconnect it to your home Wi-Fi or your mobile network after successfully configuring WLAN.

## 7. Cleaning And Maintenance

### 7.1. Warranty

eCactus warrants that we will repair or replace (at our discretion) any product or components failing due to manufacturing or material faults or defects for a period of 10 years from the initial (first) installation date.

eCactus warrants that the Product will still retain sixty percent (60%) of its Usable Energy and the ECOS app will continue functioning normally until the earlier of: (i) ten (10) years from the Warranty Start Date; or (ii) until the output has reached the Minimum Throughput Energy (as measured by the ECOS app).

The Performance Warranty will remain valid as long as the Product is used according to Appendix 1 - Usage and Transportation Requirements.

Product Model	Minimum Throughput Energy (MWh)
WH-BXB5.12	15.4
WH-BXB10.24	30.8

Please see the WEIHENG Limited Warranty to learn more.

### 7.2. Cleaning

**Power off the system before cleaning or performing any maintenance.**

**Shut down procedures:**

Step 1: Disconnect the backup load where applicable, and then turn off the backup breaker.

Step 2: Turn off the grid breaker.

Step 3: Turn off the PV switch.

Step 4: Open the battery breaker cover and turn the battery breaker to the OFF position.

Step 5: Turn the battery switch for every battery module to the OFF position.

Step 6: Close the battery breaker cover.

Power off the system before cleaning the BESS. Only clean the battery case with a soft, dry brush or vacuum cleaner to remove dirt. Do not use any solvents, abrasives, or corrosive liquids to clean the case.

### 7.3. Storage and Maintenance

Batteries are only charged to 30% capacity before transportation, and the module needs maintenance after long-term storage. Fully discharge the battery with a 0.1C current during maintenance, and then charge it to 30% with a 0.1C current. Please refer to the table below for details. Maintenance cycle at different temperatures:

Temperature	Charging interval (Months)
25°C	18
35°C	12
45°C	6

**CAUTION:**

- Battery servicing should only be performed by or under the supervision of qualified battery technicians who know the necessary precautions to take.
- Always replace batteries with the same type and quantity of batteries or battery packs.
- General instructions for battery removal and installation.
- Do not dispose of batteries in a fire. The batteries may explode.
- Do not open or damage batteries. A leaked electrolyte is harmful to the skin and eyes. It may be toxic.
- Batteries may present a risk of electrical shocks and high short-circuit currents. The following precautions should be taken when doing any work involving batteries:
  - ▶ Remove all watches, rings, or other metal objects.
  - ▶ Only use tools with insulated handles.
  - ▶ Wear rubber gloves and boots.
  - ▶ Do not lay tools or metal parts on top of batteries.
  - ▶ Disconnect charging sources prior to connecting or disconnecting battery terminals.
  - ▶ Check whether the battery is inadvertently grounded. If so, remove the ground source. Touching any part of a grounded battery may result in electrical shock. Removing battery grounds during installation and maintenance (for equipment and remote battery supplies without grounded supply circuits) minimizes the risk of electrical shocks.

## 8. Annex

### 8.1. Datasheet

<b>All-In-One Spec.</b>			
<b>Series name: Agave</b>			
<b>Model</b>	<b>WH-SPHA3.6H-5.12kWh WH-SPHA3.6H-10.24kWh</b>	<b>WH-SPHA5.0H-5.12kWh WH-SPHA5.0H-10.24kWh</b>	<b>WH-SPHA6.0H-5.12kWh WH-SPHA6.0H-10.24kWh</b>
<b>PV Input</b>			
Absolute max Voltage [d.c.V]	600		
MPPT Voltage Range [d.c.V]	100...550		
Max. DC Input Power [W]	4800	6650	8000
Start-up Voltage [d.c.V]	90		
Rated Operating Voltage [d.c.V]	360		
Max. Input Current [d.c.A]	12.5/12.5		
Max. inverter backfeed current to array[d.c.A]	0		
Isc PV[d.c.A]	18/18		
NO. of MPP Trackers	2		
NO. of Strings per MPP Tracker	1		
<b>Battery Model</b>	<b>1× WH-BXB5.12 (For models: WH-SPHA3.6H-5.12kWh WH-SPHA5.0H-5.12kWh WH-SPHA6.0H-5.12kWh)</b>	<b>2× WH-BXB5.12 (For models: WH-SPHA3.6H-10.24kWh WH-SPHA5.0H-10.24kWh WH-SPHA6.0H-10.24kWh)</b>	
Battery Capacity	LiFePO4 5.12kWh	LiFePO4 10.24kWh	
Rated Battery Voltage [d.c.V]	204.8	409.6	
Battery Voltage Range [d.c.V]	160...227.2	320...454.4	
Max. Charge/Discharge Current [d.c.A]	25/25		
Depth of Discharge [%]	90		
<b>AC Input/Output</b>			
Rated output Power [W]	3600	5000	6000
Rated Apparent Power to Grid [VA]	3600	5000	6000
Max. Apparent Power to Grid [VA]	3600	5000	6000

Max. Apparent Power from Grid [VA]	4320	6000	7200
Rated Voltage [a.c.V]	220/230/240		
Rated Frequency [Hz]	50/60		
Rated AC Current to Grid[a.c.A]	16	21.7	26.1
Rated AC Current from Grid[a.c.A]	18.8	26.1	31.3
Inrush current[a.c.A]	16 a.c.A (peak), 11.3 us (duration)		
Max. output fault current[a.c.A]	57 (peak), 40 (rms)		
AC output Maximum output overcurrent protection[a.c.A]	40		
AC input power factor	-0.8...+0.8		
AC output power factor	1(-0.8...+0.8 adjustable)		
THDi	< 3%		
<b>EPS Output (With Battery)</b>			
Max. Output Power [W]	3600	5000	6000
Rated Apparent Power [VA]	4320	6000	7200
Max. Apparent Power [VA]	4320	6000	7200
Rated Voltage [a.c.V]	230 ( $\pm 2\%$ )		
Rated Frequency [Hz]	50/60 ( $\pm 0.2\%$ )		
Rated Output Current [a.c.A]	18.8	26.1	31.3
Inrush current[a.c.A]	16 a.c.A (peak), 11.3 us (duration)		
Max. output fault current[a.c.A]	57 (peak), 40 (rms)		
EPS output Maximum output overcurrent protection[a.c.A]	40		
Switch time [ms]	< 10		
THDv @ Linear Load [%]	< 2		
Power Factor	-0.8...+0.8		
<b>Efficiency</b>			
PV Max. Efficiency[%]	97.6		
PV Europe Efficiency[%]	97		
PV Max. MPPT Efficiency[%]	99.9		
Battery Charge by PV Max. Efficiency[%]	98		
Battery Discharge Efficiency[%]	96.7		
<b>Protection</b>			
Over/Under voltage protection	Yes		
DC isolation protection	Yes		
DC injection monitoring	Yes		
Residual current detection	Yes		



Anti-islanding protection	Yes	
Over load protection	Yes	
Battery Input reverse polarity protection	Yes	
PV reverse polarity protection	Yes	
Surge protection	Yes	
Over heat protection	Yes	
<b>General Data</b>		
Dimension (W/D/H)[mm]	550*233*1125	550*233*1750
Dimension of Packing (W/D/H)[mm]	645*302*1370	655*302*2055
Net weight [kg]	68	115
Gross weight [kg]	78	130
Operation Temp [°C]	-10...+55	
Relative Humidity[%]	0...95	
Altitude [m]	<= 3000	
Ingress Protection	IP65	
Cooling	Natural	
Inverter Topology	Non-isolated	
Over voltage category	III(AC), II(DC)	
Protective class	Class I	
Active anti-islanding method	frequency shift	
Human Interface	LED/APP	
BMS Communication Interface	RS485/CAN	
Meter Communication Interface	RS485	
Noise Emission [dB]	< 25	
Standby Power Consumption [W]	< 5	
<b>Safety and Approvals</b>		
Safety	IEC62040.1:2019 AS/NZS 4777.2:2020 IEC 62109-1&-2 IEC62619 UN38.3 IEC60730-1	
EMC	EN IEC 61000-6-2:2019 EN IEC 61000-6-3:2021	

Smax=Rated for AS/NZS 4777.2

Made in China

## 9. Labels

### 9.1. Inverter Label











**EC**ACTUS

Storage System:

Type	WH-SPHA3.6H-5.12kWh	
PV INPUT	Max. DC input power	4800W
	Absolute max. voltage	DC 600V
	MPPT voltage range	DC 100...550V
	Rated operating voltage	DC 360V
	Max. input current	DC 12.5/12.5A
	Isc PV	DC 18/18A
AC INPUT	Rated voltage	AC 220/230/240V
	Rated current	AC 18.8A
	Rated frequency	50/60Hz
	Max.apparent power	4320VA
	Power factor	-0.8...+0.8
AC OUTPUT	Rated power	3600W
	Rated apparent power	3600VA
	Max. apparent power	3600VA
	Rated frequency	50/60Hz
	Rated voltage	AC 220/230/240V
	Rated output current	AC 16A
	Power factor	1(-0.8...+0.8 adjustable)
EPS OUTPUT	Rated voltage	AC 230V
	Rated output current	AC 18.8A
	Rated frequency	50/60Hz
	Rated apparent power	4320VA
	Max. apparent power	4320VA
	Power factor	-0.8...+0.8
	Battery capacity	5.12kWh
	Ingress protection	IP65
	Operation temperature range	-10°C...+55°C
	Inverter topology	Non-isolated
	Over voltage category	III (AC) ,II (DC)
	Protective class	Class I

Smax=Srated for AS/NZS 4777.2

DRM0 
 DRM1 
 DRM2 
 DRM3 
 DRM4 
 DRM5 
 DRM6 
 DRM7 
 DRM8

**Jiangsu Weiheng Intelligent Technology Co.,Ltd.**







Address:888 ChunLiuBei Road,Yangzhong City,JiangSu Province  
www.weiheng-tech.com Made in China

## 9.2. Battery Label



---

**Rechargeable Li-ion Battery System**  
 IFpP10/134/203[(16S)4S]M/0+40/90  
 Rated Capacity:25Ah  
 Model No./Nominal Voltage/Rated Energy  
 WH-BXB5.12/204.8Vd.c./5.12kWh  
 Max.Charge/Discharge Current:25A  
 Nominal Charge/Discharge Current:8.25A  
 Operating voltage range:160V...227.2V  
 Operating temperature range:  
 0°C...+45°C(Charge),-10°C...+55°C(Discharge)  
 Available SOC Range:10%...100%  
 Protection Class:I  
 IP Class:IP65

The battery should be disposed by qualified recycling agent.

 **CAUTION**

- Do not disassemble the battery pack.
- Do not immerse the battery pack in water.
- Do not short-circuit the battery.
- Do not leave the battery near by fire.

**Emergency Situations**

- \* If leaking ,fire, wet or damaged ,switch off the breaker and go away from the battery.
- \* Do not touch the leaking liquid .Do not use water.Sand or dry powder extinguisher is usable.













Manufacturer:Jiangsu Weiheng Intelligent Technology Co., Ltd.  
 Made in China